



FORTRESS[®]

FASTENERS

Product Catalogue
Bolts & Nuts

www.fortressfasteners.co.nz

m_sl
manufacturing suppliers ltd.

Fortress Catalogues Now Available

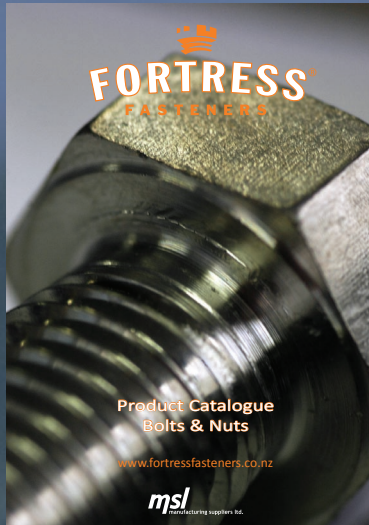

Bolts & Nuts

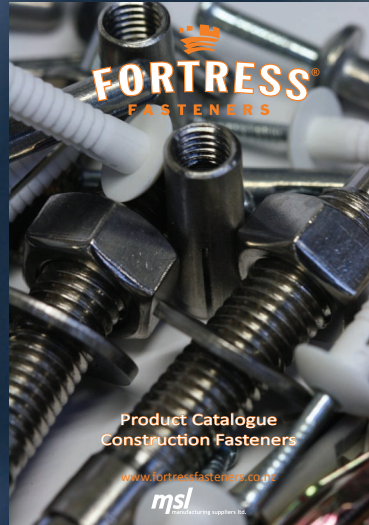

Construction Fasteners

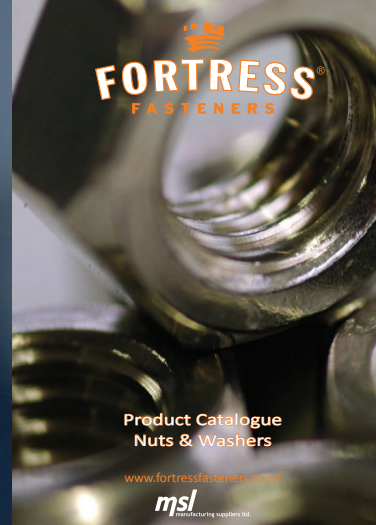

Nuts & Washers

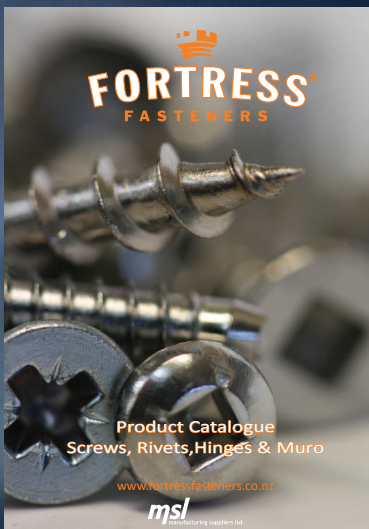

Screws, Rivets, Hinges & Muro

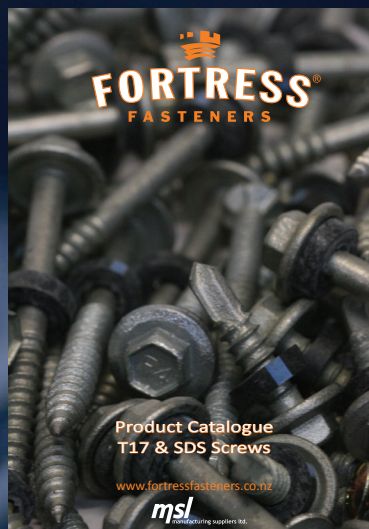

T17 & SDS Screws

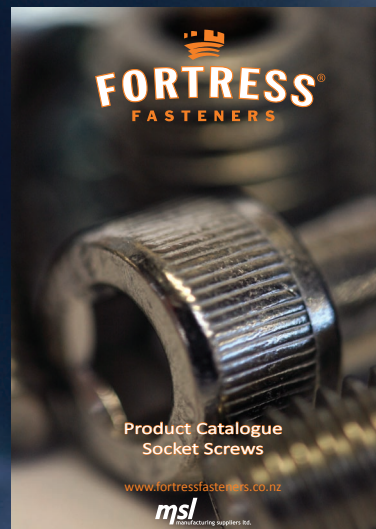

Socket Screws

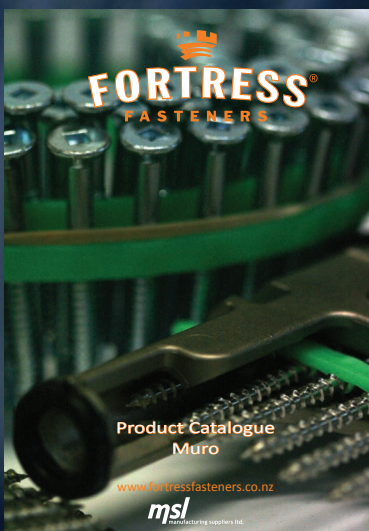

Muro - Only available online.



FORTRESS[®]
FASTENERS

Manufacturing Supplies Ltd (MSL) was the innovation of the company director in 1980 starting as a small operation in New Lynn, Auckland. It was his vision to meet industry demands for a range of quality fasteners backed by a dependable service. Thirty years on, this vision is still paramount, a service that delivers a range of fasteners on time, every time.

We have grown dramatically since the eighties with 10 branches nationwide. Our flagship being that we remain 100% New Zealand owned and operated and continue to pride ourselves on our personal service.

Today we employ over one hundred people and have a network of fully-stocked branches carrying over 200 million items and 10,000 product lines. This makes us arguably the largest fastening wholesaler in the country. Our new products, creative packaging and merchandising initiatives have also earned us a reputation as industry innovators.

We owe our success to our ability to deliver on time and in full to a wide customer base in manufacturing industries, the building trade and to building supplies merchants in New Zealand.

This, combined with the strength of our own Fortress brand and our exceptional customer service is what makes MSL a market leader.

Our local ownership means we understand the local market and have the ability to make decisions rapidly and easily. Large enough to meet the demands of any customer, we are still small enough to offer the personal touch.

Whangarei

227 Port Road, Whangarei

Phone: 09 430 0608

Fax: 09 430 0609

Auckland (Head office)

560 Rosebank Road, Avondale

Phone 09 828 2777

Fax 09 828 2424

Albany

Unit 4, 4 William Pickering Drive

Phone 09 414 7620

Fax 09 414 7410

East Tamaki

13 Carpenter Road

Phone 09 272 4070

Fax 09 272 4072

Hamilton

51 Vickery Street, Te Rapa

Phone 07 850 8434

Fax 07 850 5696

Mount Maunganui

2/9 Portside Drive

Phone 07 575 0508

Fax 07 575 0557

Hastings

199 St. Aubyn Street West

Phone 06 873 3311

Fax 06 873 3315

Palmerston North

94 Kaimanawa Street

Phone 06 355 5990

Fax 06 355 5880

Wellington

6 Regent Street, Petone

Phone 04 586 2300

Fax 04 586 2600

Christchurch

66 Hammersmith Drive, Sockburn

Phone 03 343 6740

Fax 03 343 6741



CATEGORY 01 - BOLT & NUT

- Engineers Bolt & Nut Class 4.6	Page 06
- Engineers Bolt & Nut Class 8.8	Page 09
- Stainless Steel Engineers Bolt & Nut	Page 11
- Coach Bolt & Nut	Page 13
- Stainless Steel Coach Bolt & Nut	Page 15
- Coach Screws	Page 16
- Stainless Steel Coach Screws	Page 16
- Set Screws Class 4.6	Page 17
- Set Screws Class 8.8	Page 18
- Set Screws Metric Fine	Page 18
- Stainless Steel Set Screws	Page 19
- Rag Bolt & Nut	Page 21
- Gutter Bolt & Nut	Page 21
- Joint Connector Bolt & Nut	Page 21
- Eye Bolt & Nut	Page 21
- UNC & UNF Engineers Bolt & Nut	Page 22

STRUCTURAL FASTENERS

- HSFG Bolt, Nut & Washer Class 8.8	Page 26
- HSFG Washers	Page 27
- HSFG Hex Full Nuts	Page 27
- Galv Assemblies Class 4.6	Page 27
- Purlin Flange Assemblies Class 4.6	Page 27

THREADED ROD

- Threaded Rod	Page 28
- Coupling Nuts	Page 29
- Technical Data	Page 30

ENGINEERS BOLT & NUT

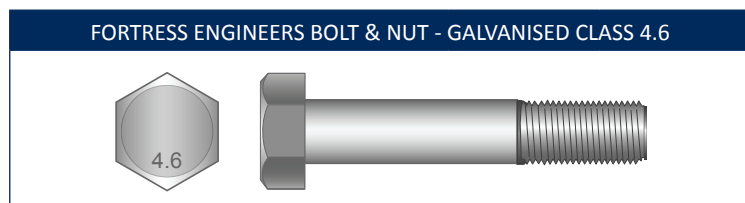

SIZE	PACK QTY	CODE
M8 X 20	100	BNM820G
M8 X 25	100	BNM825G
M8 X 30	75	BNM830G
M8 X 35	75	BNM835G
M8 X 40	75	BNM840G
M8 X 45	50	BNM845G
M8 X 50	50	BNM850G
M8 X 55	50	BNM855G
M8 X 65	50	BNM865G
M8 X 75	50	BNM875G
M8 X 90	50	BNM890G
M8 X 100	50	BNM8100G
M8 X 110	50	BNM8110G
M8 X 120	50	BNM8120G
M10 X 20	100	BNM1020G
M10 X 25	100	BNM1025G
M10 X 30	100	BNM1030G
M10 X 35	75	BNM1035G
M10 X 40	75	BNM1040G
M10 X 45	75	BNM1045G
M10 X 50	75	BNM1050G
M10 X 60	50	BNM1060G
M10 X 65	50	BNM1065G
M10 X 70	50	BNM1070G
M10 X 75	50	BNM1075G
M10 X 80	50	BNM1080G
M10 X 90	50	BNM1090G
M10 X 100	50	BNM10100G
M10 X 110	50	BNM10110G
M10 X 120	50	BNM10120G
M10 X 130	50	BNM10130G
M10 X 140	50	BNM10140G
M10 X 150	50	BNM10150G
M10 X 160	10	BNM10160G
M10 X 180	10	BNM10180G
M10 X 200	10	BNM10200G
M10 X 220	10	BNM10220G
M10 X 240	10	BNM10240G
M10 X 260	10	BNM10260G
M10 X 280	10	BNM10280G
M10 X 300	10	BNM10300G

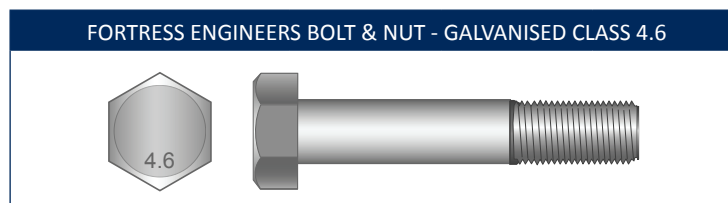

SIZE	PACK QTY	CODE
M12 X 25	75	BNM1225G
M12 X 30	75	BNM1230G
M12 X 35	50	BNM1235G
M12 X 40	50	BNM1240G
M12 X 45	50	BNM1245G
M12 X 50	50	BNM1250G
M12 X 55	50	BNM1255G
M12 X 60	25	BNM1260G
M12 X 65	25	BNM1265G
M12 X 70	25	BNM1270G
M12 X 75	25	BNM1275G
M12 X 80	25	BNM1280G
M12 X 90	25	BNM1290G
M12 X 100	25	BNM12100G
M12 X 110	25	BNM12110G
M12 X 120	25	BNM12120G
M12 X 130	25	BNM12130G
M12 X 140	25	BNM12140G
M12 X 150	25	BNM12150G
M12 X 160	10	BNM12160G
M12 X 170	10	BNM12170G
M12 X 180	10	BNM12180G
M12 X 200	10	BNM12200G
M12 X 220	10	BNM12220G
M12 X 240	10	BNM12240G
M12 X 260	10	BNM12260G
M12 X 280	10	BNM12280G
M12 X 300	10	BNM12300G
M12 X 325	10	BNM12325G
M12 X 350	10	BNM12350G
M12 X 375	10	BNM12375G
M12 X 400	10	BNM12400G
M12 X 450	10	BNM12450G
M16 X 25	25	BNM1625G
M16 X 30	25	BNM1630G
M16 X 35	25	BNM1635G
M16 X 40	25	BNM1640G
M16 X 45	25	BNM1645G
M16 X 50	25	BNM1650G
M16 X 55	25	BNM1655G
M16 X 60	25	BNM1660G
M16 X 65	20	BNM1665G
M16 X 70	20	BNM1670G

FORTRESS ENGINEERS BOLT & NUT - GALVANISED CLASS 4.6



SIZE	PACK QTY	CODE
M16 X 75	20	BNM1675G
M16 X 80	20	BNM1680G
M16 X 90	20	BNM1690G
M16 X 100	15	BNM16100G
M16 X 110	15	BNM16110G
M16 X 120	15	BNM16120G
M16 X 130	15	BNM16130G
M16 X 140	15	BNM16140G
M16 X 150	15	BNM16150G
M16 X 160	10	BNM16160G
M16 X 180	10	BNM16180G
M16 X 200	10	BNM16200G
M16 X 220	10	BNM16220G
M16 X 240	10	BNM16240G
M16 X 260	10	BNM16260G
M16 X 280	10	BNM16280G
M16 X 300	10	BNM16300G
M16 X 325	5	BNM16325G
M16 X 350	5	BNM16350G
M16 X 375	5	BNM16375G
M16 X 400	5	BNM16400G
M16 X 425	5	BNM16425G
M16 X 450	5	BNM16450G
M16 X 475	5	BNM16475G
M16 X 500	5	BNM16500G
M16 X 525	5	BNM16525G
M16 X 550	5	BNM16550G
M16 X 575	5	BNM16575G
M16 X 600	5	BNM16600G
M20 X 40	10	BNM2040G
M20 X 45	10	BNM2045G
M20 X 50	10	BNM2050G
M20 X 55	10	BNM2055G
M20 X 60	10	BNM2060G
M20 X 65	10	BNM2065G
M20 X 70	10	BNM2070G
M20 X 75	10	BNM2075G
M20 X 80	10	BNM2080G
M20 X 90	10	BNM2090G
M20 X 100	10	BNM20100G
M20 X 110	10	BNM20110G
M20 X 120	10	BNM20120G
M20 X 130	10	BNM20130G
M20 X 140	10	BNM20140G

FORTRESS ENGINEERS BOLT & NUT - GALVANISED CLASS 4.6



SIZE	PACK QTY	CODE
M20 X 150	10	BNM20150G
M20 X 160	10	BNM20160G
M20 X 180	10	BNM20180G
M20 X 200	10	BNM20200G
M20 X 220	10	BNM20220G
M20 X 240	5	BNM20240G
M20 X 260	5	BNM20260G
M20 X 280	5	BNM20280G
M20 X 300	5	BNM20300G
M20 X 325	5	BNM20325G
M20 X 350	5	BNM20350G
M20 X 375	5	BNM20375G
M20 X 400	5	BNM20400G
M20 X 450	5	BNM20450G
M20 X 500	5	BNM20500G
M20 X 550	5	BNM20550G
M20 X 600	5	BNM20600G
M24 X 50	10	BNM2450G
M24 X 60	10	BNM2460G
M24 X 65	10	BNM2465G
M24 X 80	10	BNM2480G
M24 X 90	10	BNM2490G
M24 X 100	10	BNM24100G
M24 X 110	10	BNM24110G
M24 X 120	10	BNM24120G
M24 X 130	5	BNM24130G
M24 X 140	5	BNM24140G
M24 X 150	5	BNM24150G
M24 X 160	5	BNM24160G
M24 X 180	5	BNM24180G
M24 X 200	5	BNM24200G
M24 X 220	5	BNM24220G
M24 X 240	5	BNM24240G
M24 X 260	5	BNM24260G
M24 X 280	5	BNM24280G
M24 X 300	5	BNM24300G
M24 X 350	5	BNM24350G
M24 X 450	5	BNM24450G
M24 X 500	5	BNM24500G
M24 X 550	5	BNM24550G
M24 X 600	5	BNM24600G
M24 X 750	5	BNM24750G

FORTRESS ENGINEERS BOLT & NUT - GALVANISED CLASS 4.6



SIZE	PACK QTY	CODE
M27 X 120	5	BNM27120G
M30 X 110	5	BNM30110G
M30 X 120	5	BNM30120G
M30 X 130	5	BNM30130G
M30 X 140	5	BNM30140G
M30 X 160	5	BNM30160G
M30 X 180	5	BNM30180G

FORTRESS ENGINEERS BOLT & NUT - ZINC PLATED CLASS 4.6

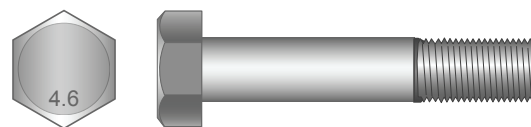

SIZE	PACK QTY	CODE
M8 X 70	50	BNM870Z
M8 X 75	50	BNM875Z
M8 X 80	75	BNM880Z
M8 X 90	50	BNM890Z
M8 X 100	50	BNM8100Z
M8 X 110	50	BNM8110Z
M8 X 120	50	BNM8120Z
M10 X 20	100	BNM1020Z
M10 X 25	100	BNM1025Z
M10 X 30	100	BNM1030Z
M10 X 35	75	BNM1035Z
M10 X 40	75	BNM1040Z
M10 X 45	75	BNM1045Z
M10 X 50	75	BNM1050Z
M10 X 60	50	BNM1060Z
M10 X 65	50	BNM1065Z
M10 X 70	50	BNM1070Z
M10 X 75	50	BNM1075Z
M10 X 80	50	BNM1080Z
M10 X 90	50	BNM1090Z
M10 X 100	50	BNM10100Z
M10 X 110	25	BNM10110Z
M10 X 120	25	BNM10120Z
M10 X 130	25	BNM10130Z
M10 X 140	50	BNM10140Z
M10 X 150	50	BNM10150Z
M12 X 25	50	BNM1225Z
M12 X 30	50	BNM1230Z
M12 X 35	50	BNM1235Z
M12 X 40	50	BNM1240Z
M12 X 45	50	BNM1245Z
M12 X 50	50	BNM1250Z
M12 X 55	50	BNM1255Z
M12 X 60	50	BNM1260Z
M12 X 65	50	BNM1265Z
M12 X 70	50	BNM1270Z
M12 X 80	50	BNM1280Z
M12 X 90	50	BNM1290Z
M12 X 100	25	BNM12100Z
M12 X 110	25	BNM12110Z
M12 X 120	25	BNM12120Z
M12 X 130	25	BNM12130Z
M16 X 30	25	BNM1630Z

FORTRESS ENGINEERS BOLT & NUT - ZINC PLATED CLASS 4.6



SIZE	PACK QTY	CODE
M6 X 12	200	BNM612Z
M6 X 16	200	BNM616Z
M6 X 20	200	BNM620Z
M6 X 25	200	BNM625Z
M6 X 30	150	BNM630Z
M6 X 35	150	BNM635Z
M6 X 40	150	BNM640Z
M6 X 45	150	BNM645Z
M6 X 50	150	BNM650Z
M6 X 55	150	BNM655Z
M6 X 60	150	BNM660Z
M6 X 65	150	BNM665Z
M6 X 70	150	BNM670Z
M6 X 75	150	BNM675Z
M6 X 80	125	BNM680Z
M6 X 90	100	BNM690Z
M6 X 100	100	BNM6100Z
M6 X 110	100	BNM6110Z
M8 X 20	100	BNM820Z
M8 X 25	75	BNM825Z
M8 X 30	75	BNM830Z
M8 X 35	75	BNM835Z
M8 X 40	75	BNM840Z
M8 X 45	50	BNM845Z
M8 X 50	50	BNM850Z
M8 X 55	50	BNM855Z
M8 X 60	50	BNM860Z
M8 X 65	50	BNM865Z

FORTRESS ENGINEERS BOLT & NUT - ZINC PLATED CLASS 4.6



SIZE	PACK QTY	CODE
M16 X 40	25	BNM1640Z
M16 X 50	25	BNM1650Z
M16 X 60	25	BNM1660Z
M16 X 65	25	BNM1665Z
M16 X 70	25	BNM1670Z
M16 X 75	10	BNM1675Z
M16 X 80	10	BNM1680Z
M16 X 90	10	BNM1690Z
M16 X 100	10	BNM16100Z
M20 X 45	10	BNM2045Z
M20 X 50	10	BNM2050Z
M20 X 65	10	BNM2065Z
M20 X 70	10	BNM2070Z
M20 X 75	10	BNM2075Z
M20 X 90	10	BNM2090Z
M20 X 100	10	BNM20100Z
M20 X 110	10	BNM20110Z
M20 X 140	10	BNM20140Z

FORTRESS ENGINEERS BOLT & NUT - ZINC PLATED CLASS 8.8

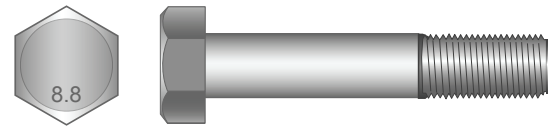

SIZE	PACK QTY	CODE
M6 X 16	200	BNHM616Z
M6 X 20	200	BNHM620Z
M6 X 25	200	BNHM625Z
M6 X 30	150	BNHM630Z
M6 X 35	150	BNHM635Z
M6 X 40	150	BNHM640Z
M6 X 45	100	BNHM645Z
M6 X 50	100	BNHM650Z
M6 X 55	100	BNHM655Z
M6 X 60	100	BNHM660Z
M6 X 65	100	BNHM665Z
M6 X 70	100	BNHM670Z
M6 X 80	100	BNHM680Z
M6 X 90	100	BNHM690Z
M6 X 100	75	BNHM6100Z
M8 X 16	125	BNHM816Z
M8 X 20	100	BNHM820Z
M8 X 25	100	BNHM825Z
M8 X 30	75	BNHM830Z
M8 X 35	75	BNHM835Z
M8 X 40	75	BNHM840Z
M8 X 45	50	BNHM845Z
M8 X 50	50	BNHM850Z
M8 X 55	50	BNHM855Z
M8 X 60	50	BNHM860Z
M8 X 65	50	BNHM865Z
M8 X 70	50	BNHM870Z
M8 X 75	50	BNHM875Z
M8 X 80	50	BNHM880Z
M8 X 90	50	BNHM890Z
M8 X 100	50	BNHM8100Z
M8 X 110	50	BNHM8110Z
M10 X 20	100	BNHM1020Z
M10 X 25	100	BNHM1025Z
M10 X 30	100	BNHM1030Z
M10 X 35	75	BNHM1035Z
M10 X 40	75	BNHM1040Z
M10 X 50	75	BNHM1050Z
M10 X 55	50	BNHM1055Z
M10 X 60	50	BNHM1060Z
M10 X 65	50	BNHM1065Z
M10 X 70	50	BNHM1070Z

CATEGORY 01 - BOLT & NUT

Standard: 8.8 BOLTS - AS 1110. NUTS - AS1112

FORTRESS ENGINEERS BOLT & NUT - ZINC PLATED CLASS 8.8

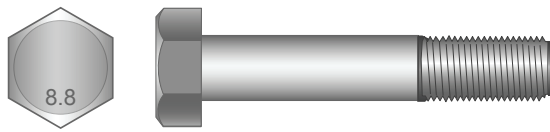

SIZE	PACK QTY	CODE
M10 X 75	50	BNHM1075Z
M10 X 80	50	BNHM1080Z
M10 X 90	50	BNHM1090Z
M10 X 100	50	BNHM10100Z
M10 X 110	25	BNHM10110Z
M10 X 120	25	BNHM10120Z
M10 X 130	25	BNHM10130Z
M10 X 140	25	BNHM10140Z
M10 X 150	25	BNHM10150Z
M12 X 25	75	BNHM1225Z
M12 X 30	75	BNHM12130Z
M12 X 35	50	BNHM1235Z
M12 X 40	50	BNHM1240Z
M12 X 45	50	BNHM1245Z
M12 X 50	50	BNHM1250Z
M12 X 55	25	BNHM1255Z
M12 X 60	25	BNHM1260Z
M12 X 65	25	BNHM1265Z
M12 X 70	25	BNHM1270Z
M12 X 75	25	BNHM1275Z
M12 X 80	25	BNHM1280Z
M12 X 90	25	BNHM1290Z
M12 X 100	25	BNHM12100Z
M12 X 110	25	BNHM12110Z
M12 X 120	25	BNHM12120Z
M12 X 130	25	BNHM12130Z
M12 X 140	25	BNHM12140Z
M12 X 150	25	BNHM12150Z
M12 X 160	25	BNHM12160Z
M12 X 170	25	BNHM12170Z
M12 X 180	25	BNHM12180Z
M12 X 200	10	BNHM12200Z
M14 X 25	25	BNHM1425Z
M14 X 40	25	BNHM1440Z
M14 X 50	25	BNHM1450Z
M14 X 60	25	BNHM1460Z
M14 X 100	25	BNHM14100Z
M16 X 30	25	BNHM16030Z
M16 X 35	25	BNHM1635Z
M16 X 40	25	BNHM1640Z
M16 X 45	25	BNHM1645Z
M16 X 50	25	BNHM1650Z
M16 X 55	25	BNHM1655Z
M16 X 60	25	BNHM1660Z

FORTRESS ENGINEERS BOLT & NUT - ZINC PLATED CLASS 8.8



SIZE	PACK QTY	CODE
M16 X 65	25	BNHM1665Z
M16 X 70	20	BNHM1670Z
M16 X 75	20	BNHM1675Z
M16 X 80	20	BNHM1680Z
M16 X 90	20	BNHM1690Z
M16 X 100	15	BNHM16100Z
M16 X 110	15	BNHM16110Z
M16 X 120	15	BNHM16120Z
M16 X 130	15	BNHM16130Z
M16 X 140	15	BNHM16140Z
M16 X 150	15	BNHM16150Z
M16 X 170	15	BNHM16170Z
M16 X 220	15	BNHM16220Z
M20 X 40	15	BNHM2040Z
M20 X 45	15	BNHM2045Z
M20 X 50	15	BNHM2050Z
M20 X 55	15	BNHM2055Z
M20 X 60	15	BNHM2060Z
M20 X 65	15	BNHM2065Z
M20 X 70	15	BNHM2070Z
M20 X 75	15	BNHM2075Z
M20 X 80	10	BNHM2080Z
M20 X 90	10	BNHM2090Z
M20 X 100	10	BNHM20100Z
M20 X 110	10	BNHM20110Z
M20 X 150	10	BNHM20150Z
M20 X 180	10	BNHM20180Z
M20 X 190	5	BNHM20190Z
M20 X 200	5	BNHM20200Z
M24 X 50	5	BNHM2450Z
M24 X 65	5	BNHM2465Z
M24 X 90	5	BNHM2490Z
M24 X 100	5	BNHM24100Z
M24 X 110	5	BNHM24110Z
M24 X 140	5	BNHM24140Z
M24 X 160	5	BNHM24160Z

Headmarkings

A2=304 Stainless Steel - A4=316 Stainless Steel

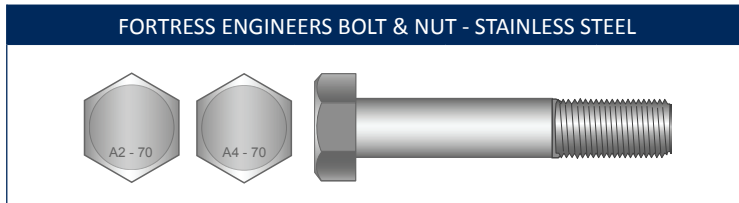

SIZE	PACK QTY	T304 (A2)	T316 (A4)
M6 X 40	50	BNXM640	BNXM640T
M6 X 45	50	BNXM645	BNXM645T
M6 X 50	50	BNXM650	BNXM650T
M6 X 55	50	BNXM655	BNXM655T
M6 X 60	50	BNXM660	BNXM660T
M6 X 65	50	BNXM665	BNXM665T
M6 X 70	50	BNXM670	BNXM670T
M6 X 75	50	BNXM675	BNXM675T
M6 X 80	50	BNXM680	BNXM680T
M6 X 90	50	BNXM690	BNXM690T
M6 X 130	50	BNXM6130	BNXM6130T
M8 X 35	25	BNXM835	BNXM835T
M8 X 40	25	BNXM840	BNXM840T
M8 X 45	25	BNXM845	BNXM845T
M8 X 50	25	BNXM850	BNXM850T
M8 X 60	25	BNXM865	BNXM865T
M8 X 65	25	BNXM865	BNXM865T
M8 X 70	25	BNXM870	BNXM870T
M8 X 80	25	BNXM880	BNXM880T
M8 X 90	25	BNXM890	BNXM890T
M8 X 100	25	BNXM8100	BNXM8100T
M8 X 110	25	BNXM8110	BNXM8110T
M8 X 130	25	BNXM8130	BNXM8130T
M10 X 40	25	BNXM1040	BNXM1040T
M10 X 50	25	BNXM1050	BNXM1050T
M10 X 60	25	BNXM1060	BNXM1060T
M10 X 65	25	BNXM1065	BNXM1065T
M10 X 70	25	BNXM1070	BNXM1070T
M10 X 75	25	BNXM1075	BNXM1075T
M10 X 80	25	BNXM1080	BNXM1080T
M10 X 90	25	BNXM1090	BNXM1090T
M10 X 100	25	BNXM10100	BNXM10100T
M10 X 110	25	BNXM10110	BNXM10110T
M10 X 120	25	BNXM10120	BNXM10120T
M10 X 130	25	BNXM10130	BNXM10130T
M10 X 150	25	BNXM10150	BNXM10150T
M12 X 40	25	BNXM1240	BNXM1240T
M12 X 45	25	BNXM1245	BNXM1245T
M12 X 50	25	BNXM1250	BNXM1250T
M12 X 55	25	BNXM1255	BNXM1255T
M12 X 60	25	BNXM1260	BNXM1260T
M12 X 65	25	BNXM1265	BNXM1265T

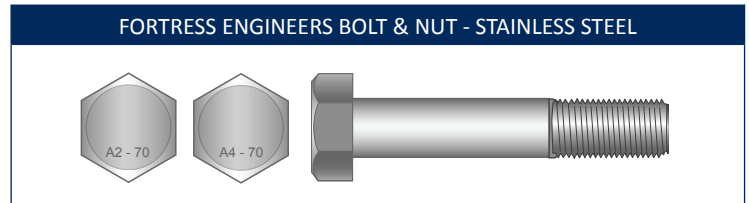

SIZE	PACK QTY	T304 (A2)	T316 (A4)
M12 X 70	25	BNXM1270	BNXM1270T
M12 X 75	25	BNXM1275	BNXM1275T
M12 X 80	25	BNXM1290	BNXM1290T
M12 X 90	25	BNXM1290	BNXM1290T
M12 X 100	25	BNXM12100	BNXM12100T
M12 X 110	25	BNXM12110	BNXM12110T
M12 X 120	25	BNXM12120	BNXM12120T
M12 X 130	25	BNXM12130	BNXM12130T
M12 X 140	25	BNXM12140	BNXM12140T
M12 X 150	25	BNXM12150	BNXM12150T
M12 X 160	10	BNXM12160	BNXM12160T
M12 X 180	10	BNXM12180	BNXM12180T
M12 X 200	10	BNXM12200	BNXM12200T
M12 X 220	5	BNXM12220	BNXM12220T
M12 X 240	5	BNXM12240	BNXM12240T
M12 X 260	5	BNXM12260	BNXM12260T
M12 X 280	5	BNXM12280	BNXM12280T
M12 X 300	5	BNXM12300	BNXM12300T
M16 X 65	10	BNXM1665	BNXM1665T
M16 X 70	10	BNXM1670	BNXM1670T
M16 X 75	10	BNXM1675	BNXM1675T
M16 X 80	10	BNXM1680	BNXM1680T
M16 X 90	10	BNXM1690	BNXM1690T
M16 X 100	10	BNXM16100	BNXM16100T
M16 X 110	10	BNXM16110	BNXM16110T
M16 X 120	10	BNXM16120	BNXM16120T
M16 X 130	10	BNXM16130	BNXM16130T
M16 X 140	10	BNXM16140	BNXM16140T
M16 X 150	10	BNXM16150	BNXM16150T
M16 X 160	10	BNXM16160	BNXM16160T
M16 X 180	5	BNXM16180	BNXM16180T
M16 X 200	5	BNXM16200	BNXM16200T
M16 X 220	5	BNXM16220	BNXM16220T
M16 X 240	5	BNXM16240	BNXM16240T
M16 X 260	5	BNXM16260	BNXM16260T
M16 X 280	5	BNXM16280	BNXM16280T
M16 X 300	5	BNXM16300	BNXM16300T
M16 X 350	5	BNXM16350	BNXM16350T
M16 X 400	5	BNXM16400	BNXM16400T
M20 X 60	5	BNXM2060	BNXM2060T
M20 X 65	5	BNXM2065	BNXM2065T
M20 X 70	5	BNXM2070	BNXM2070T

FORTRESS ENGINEERS BOLT & NUT - STAINLESS STEEL

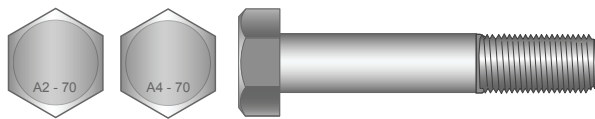

SIZE	PACK QTY	T304 (A2)	T316 (A4)
M20 X 75	5	BNXM2075	BNXM2075T
M20 X 80	5	BNXM2080	BNXM2080T
M20 X 90	5	BNXM2090	BNXM2090T
M20 X 100	5	BNXM20100	BNXM20100T
M20 X 110	5	BNXM20110	BNXM20110T
M20 X 120	5	BNXM20120	BNXM20120T
M20 X 130	5	BNXM20130	BNXM20130T
M20 X 150	5	BNXM20150	BNXM20150T
M20 X 160	5	BNXM20160	BNXM20160T
M20 X 180	5	BNXM20180	BNXM20180T
M20 X 200	5	BNXM20200	BNXM20200T
M20 X 240	5	BNXM20240	BNXM20240T
M20 X 300	5	BNXM20300	BNXM20300T
M24 X 70	5	BNXM2470	BNXM2470T
M24 X 75	5	BNXM2475	BNXM2475T
M24 X 80	5	BNXM2480	BNXM2480T
M24 X 90	5	BNXM2490	BNXM2490T
M24 X 100	5	BNXM24100	BNXM24100T
M24 X 110	5	BNXM24110	BNXM24110T
M24 X 120	5	BNXM24120	BNXM24120T
M24 X 130	5	BNXM24130	BNXM24130T
M24 X 140	5	BNXM24140	BNXM24140T
M24 X 150	5	BNXM24150	BNXM24150T
M24 X 160	5	BNXM24160	BNXM24160T
M24 X 180	5	BNXM24180	BNXM24180T
M24 X 200	5	BNXM24200	BNXM24200T
M24 X 250	5	BNXM24250	BNXM24250T

All Stainless Steel stock is subject to availability at time of order.

ENGINEERED FASTENERS

Quality in Design.



- Captive Screws • Sheetmetal Nuts •
- Studs & Pins • Standoffs •
- Cable Tie Mounts & Hooks •



COACH BOLT & NUT

FORTRESS COACH BOLT & NUT - GALVANISED CLASS 4.6		
SIZE	PACK QTY	CODE
M8 X 20	100	CBNM820G
M8 X 25	100	CBNM825G
M8 X 30	75	CBNM830G
M8 X 40	75	CBNM840G
M8 X 50	50	CBNM850G
M8 X 60	50	CBNM860G
M8 X 65	50	CBNM865G
M8 X 75	50	CBNM875G
M8 X 80	50	CBNM880G
M8 X 90	50	CBNM890G
M8 X 95	50	CBNM895G
M8 X 100	50	CBNM8100G
M8 X 110	50	CBNM8110G
M8 X 130	50	CBNM8130G
M8 X 140	50	CBNM8140G
M8 X 150	50	CBNM8150G
M8 X 160	50	CBNM8160G
M8 X 180	50	CBNM8180G
M10 X 25	100	CBNM1025G
M10 X 30	100	CBNM1030G
M10 X 40	75	CBNM1040G
M10 X 50	75	CBNM1050G
M10 X 60	50	CBNM1060G
M10 X 65	50	CBNM1065G
M10 X 70	50	CBNM1070G
M10 X 75	50	CBNM1075G
M10 X 80	50	CBNM1080G
M10 X 90	50	CBNM1090G
M10 X 100	50	CBNM10100G
M10 X 110	50	CBNM10110G
M10 X 120	50	CBNM10120G
M10 X 130	50	CBNM10130G
M10 X 140	50	CBNM10140G
M10 X 150	50	CBNM10150G
M10 X 160	10	CBNM10160G
M10 X 170	10	CBNM10170G
M10 X 180	10	CBNM10180G
M10 X 190	10	CBNM10190G
M10 X 200	10	CBNM10200G
M10 X 220	10	CBNM10220G
M10 X 240	10	CBNM10240G
M10 X 260	10	CBNM10260G
M10 X 280	10	CBNM10280G

FORTRESS COACH BOLT & NUT - GALVANISED CLASS 4.6		
SIZE	PACK QTY	CODE
M10 X 300	10	CBNM10300G
M10 X 350	10	CBNM10350G
M12 X 30	50	CBNM1230G
M12 X 40	50	CBNM1240G
M12 X 50	50	CBNM1250G
M12 X 60	25	CBNM1260G
M12 X 65	25	CBNM1265G
M12 X 70	25	CBNM1270G
M12 X 75	25	CBNM1275G
M12 X 90	25	CBNM1290G
M12 X 100	25	CBNM12100G
M12 X 110	25	CBNM12110G
M12 X 120	25	CBNM12120G
M12 X 130	25	CBNM12130G
M12 X 140	25	CBNM12140G
M12 X 150	25	CBNM12150G
M12 X 160	10	CBNM12160G
M12 X 170	10	CBNM12170G
M12 X 180	10	CBNM12180G
M12 X 190	10	CBNM12190G
M12 X 200	10	CBNM12200G
M12 X 220	10	CBNM12220G
M12 X 240	10	CBNM12240G
M12 X 260	10	CBNM12260G
M12 X 280	10	CBNM12280G
M12 X 300	10	CBNM12300G
M12 X 325	10	CBNM12325G
M12 X 350	10	CBNM12350G
M12 X 375	10	CBNM12375G
M12 X 400	10	CBNM12400G
M16 X 50	10	CBNM1650G
M16 X 65	10	CBNM1665G
M16 X 75	10	CBNM1675G
M16 X 90	10	CBNM1690G
M16 X 100	10	CBNM16100G
M16 X 110	10	CBNM16110G
M16 X 150	10	CBNM16150G
M16 X 160	10	CBNM16160G
M16 X 180	10	CBNM16180G
M16 X 200	10	CBNM16200G
M16 X 220	10	CBNM16220G
M16 X 240	10	CBNM16240G
M16 X 250	10	CBNM16250G

FORTRESS COACH BOLT & NUT - GALVANISED CLASS 4.6

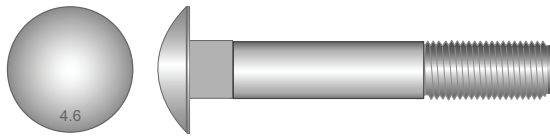

SIZE	PACK QTY	CODE
M16 X 260	10	CBNM16260G
M16 X 280	10	CBNM16280G
M16 X 300	5	CBNM16300G
M16 X 325	5	CBNM16325G
M16 X 350	5	CBNM16350G
M16 X 400	5	CBNM16400G
M20 X 100	5	CBNM20100G
M20 X 130	5	CBNM20130G
M20 X 150	5	CBNM20150G
M20 X 180	5	CBNM20180G
M20 X 200	5	CBNM20200G
M20 X 240	5	CBNM20240G
M20 X 260	5	CBNM20260G
M20 X 300	5	CBNM20300G
M20 X 350	5	CBNM20350G
M20 X 450	5	CBNM20450G

FORTRESS COACH BOLT & NUT - ZINC PLATED CLASS 4.6

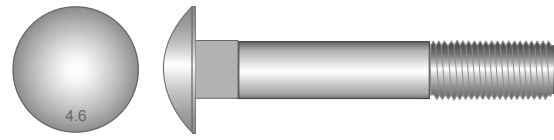

SIZE	PACK QTY	CODE
M8 X 20	100	CBNM820Z
M8 X 25	100	CBNM825Z
M8 X 30	75	CBNM830Z
M8 X 40	75	CBNM840Z
M8 X 45	50	CBNM845Z
M8 X 50	50	CBNM850Z
M8 X 60	50	CBNM860Z
M8 X 65	50	CBNM865Z
M8 X 70	50	CBNM870Z
M8 X 75	50	CBNM875Z
M8 X 80	50	CBNM880Z
M8 X 90	50	CBNM890Z
M8 X 100	50	CBNM8100Z
M8 X 110	50	CBNM8110Z
M8 X 150	50	CBNM8150Z
M10 X 20	100	CBNM1020Z
M10 X 25	100	CBNM1025Z
M10 X 30	100	CBNM1030Z
M10 X 40	75	CBNM1040Z
M10 X 50	75	CBNM1050Z
M10 X 65	50	CBNM1065Z
M10 X 90	50	CBNM1090Z
M10 X 100	50	CBNM10100Z
M10 X 110	50	CBNM10110Z
M10 X 130	50	CBNM10130Z

FORTRESS COACH BOLT & NUT - ZINC PLATED CLASS 4.6

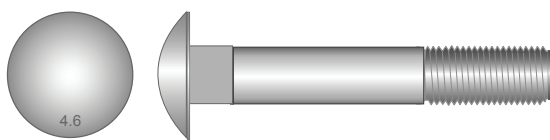

CODE	PACK QTY	CODE
M6 X 20	200	CBNM620Z
M6 X 25	200	CBNM625Z
M6 X 30	150	CBNM630Z
M6 X 35	150	CBNM635Z
M6 X 40	150	CBNM640Z
M6 X 50	150	CBNM650Z
M6 X 55	150	CBNM655Z
M6 X 60	150	CBNM660Z
M6 X 65	150	CBNM665Z
M6 X 70	150	CBNM670Z
M6 X 75	125	CBNM675Z
M6 X 90	100	CBNM690Z
M6 X 100	100	CBNM6100Z
M6 X 110	100	CBNM6110Z
M6 X 130	100	CBNM6130Z
M6 X 150	100	CBNM6150Z

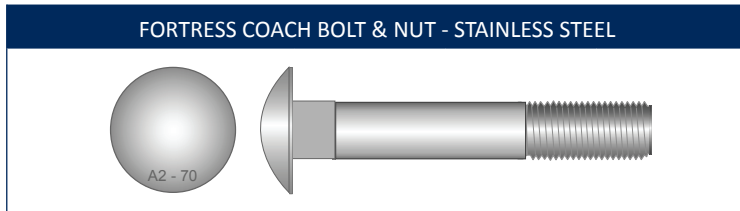

SIZE	PACK QTY	T304 (A2)	T316 (A4)
M6 X 25	50	CBNXM625	CBNXM625T
M6 X 30	50	CBNXM630	CBNXM630T
M6 X 40	50	CBNXM640	CBNXM640T
M6 X 50	50	CBNXM650	CBNXM650T
M6 X 60	50	CBNXM660	CBNXM660T
M6 X 75	50	CBNXM675	CBNXM675T
M6 X 80	50	CBNXM680	CBNXM680T
M8 X 20	25	CBNXM820	CBNXM820T
M8 X 25	25	CBNXM825	CBNXM825T
M8 X 30	25	CBNXM830	CBNXM830T
M8 X 40	25	CBNXM840	CBNXM840T
M8 X 50	25	CBNXM850	CBNXM850T
M8 X 65	25	CBNXM865	CBNXM865T
M8 X 70	25	CBNXM870	CBNXM870T
M8 X 75	25	CBNXM875	CBNXM875T
M8 X 90	25	CBNXM890	CBNXM890T
M8 X 100	25	CBNXM8100	CBNXM8100T
M8 X 110	25	CBNXM8130	CBNXM8130T
M8 X 130	25	CBNXM8130	CBNXM8130T
M8 X 140	25	CBNXM8140	CBNXM8140T
M8 X 150	25	CBNXM8150	CBNXM8150T
M10 X 40	25	CBNXM1040	CBNXM1040T
M10 X 50	25	CBNXM1050	CBNXM1050T
M10 X 60	25	CBNXM1060	CBNXM1060T
M10 X 65	25	CBNXM1065	CBNXM1065T
M10 X 70	25	CBNXM1070	CBNXM1070T
M10 X 75	25	CBNXM1075	CBNXM1075T
M10 X 80	25	CBNXM1080	CBNXM1080T
M10 X 90	25	CBNXM1090	CBNXM1090T
M10 X 100	25	CBNXM10100	CBNXM10100T
M10 X 110	25	CBNXM10110	CBNXM10110T
M10 X 120	25	CBNXM10120	CBNXM10120T
M10 X 130	25	CBNXM10130	CBNXM10130T
M10 X 140	25	CBNXM10140	CBNXM10140T
M10 X 150	25	CBNXM10150	CBNXM10150T
M10 X 160	25	CBNXM10160	CBNXM10160T
M10 X 180	10	CBNXM10180	CBNXM10180T
M10 X 190	10	CBNXM10190	CBNXM10190T
M10 X 200	10	CBNXM10200	CBNXM10200T
M10 X 220	10	CBNXM10220	CBNXM10220T
M10 X 240	10	CBNXM10240	CBNXM10240T

All Stainless Steel stock is subject to availability at time of order.

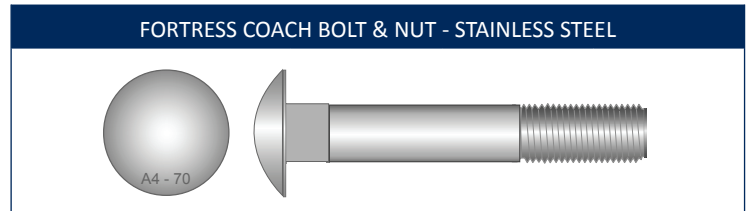

SIZE	PACK QTY	T304 (A2)	T316 (A4)
M10 X 260	10	CBNXM10260	CBNXM10260T
M10 X 280	10	CBNXM10280	CBNXM10280T
M10 X 300	10	CBNXM10300	CBNXM10300T
M12 X 40	25	CBNXM1240	CBNXM1240T
M12 X 50	25	CBNXM1250	CBNXM1250T
M12 X 60	25	CBNXM1260	CBNXM1260T
M12 X 65	25	CBNXM1265	CBNXM1265T
M12 X 75	25	CBNXM1275	CBNXM1275T
M12 X 80	25	CBNXM1280	CBNXM1280T
M12 X 90	25	CBNXM1290	CBNXM1290T
M12 X 100	25	CBNXM12100	CBNXM12100T
M12 X 110	25	CBNXM12110	CBNXM12110T
M12 X 120	25	CBNXM12120	CBNXM12120T
M12 X 130	25	CBNXM12130	CBNXM12130T
M12 X 140	25	CBNXM12140	CBNXM12140T
M12 X 150	25	CBNXM12150	CBNXM12150T
M12 X 160	10	CBNXM12160	CBNXM12160T
M12 X 170	10	CBNXM12170	CBNXM12170T
M12 X 180	10	CBNXM12180	CBNXM12180T
M12 X 200	10	CBNXM12200	CBNXM12200T
M12 X 220	5	CBNXM12220	CBNXM12220T
M12 X 240	5	CBNXM12240	CBNXM12240T
M12 X 260	5	CBNXM12260	CBNXM12260T
M12 X 280	5	CBNXM12280	CBNXM12280T
M12 X 300	5	CBNXM12300	CBNXM12300T
M16 X 50	10	CBNXM1650	CBNXM1650T
M16 X 65	10	CBNXM1665	CBNXM1665T
M16 X 90	10	CBNXM1690	CBNXM1690T
M16 X 100	10	CBNXM16100	CBNXM16100T
M16 X 110	10	CBNXM16110	CBNXM16110T
M16 X 130	10	CBNXM16130	CBNXM16130T
M16 X 150	10	CBNXM16150	CBNXM16150T
M16 X 180	10	CBNXM16180	CBNXM16180T
M16 X 200	10	CBNXM16200	CBNXM16200T
M16 X 220	5	CBNXM16220	CBNXM16220T
M16 X 240	5	CBNXM16240	CBNXM16240T
M16 X 260	5	CBNXM16260	CBNXM16260T
M16 X 280	5	CBNXM16280	CBNXM16280T
M16 X 300	5	CBNXM16300	CBNXM16300T
M20 X 130	5	CBNXM20130	CBNXM20130T
M20 X 180	5	CBNXM20180	CBNXM20180T
M20 X 200	5	CBNXM20200	CBNXM20200T

COACH SCREWS

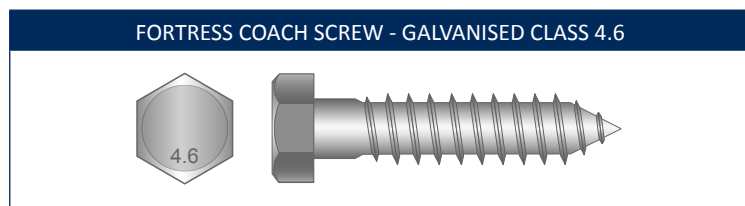

SIZE	PACK QTY	CODE
6MM X 40	150	CSM640G
6MM X 50	150	CSM650G
6MM X 65	150	CSM665G
6MM X 75	125	CSM675G
6MM X 90	100	CSM690G
6MM X 100	100	CSM6100G
8MM X 40	75	CSM840G
8MM X 50	75	CSM850G
8MM X 65	75	CSM865G
8MM X 75	75	CSM875G
8MM X 90	50	CSM890G
8MM X 100	50	CSM8100G
10MM X 40	75	CSM1040G
10MM X 50	75	CSM1050G
10MM X 65	50	CSM1065G
10MM X 75	50	CSM1075G
10MM X 90	50	CSM1090G
10MM X 100	50	CSM10100G
10MM X 120	50	CSM10120G
10MM X 130	50	CSM10130G
10MM X 150	50	CSM10150G
10MM X 160	25	CSM10160G
10MM X 180	25	CSM10180G
12MM X 40	50	CSM1240G
12MM X 50	50	CSM1250G
12MM X 65	50	CSM1265G
12MM X 75	25	CSM1275G
12MM X 90	25	CSM1290G
12MM X 100	25	CSM12100G
12MM X 120	25	CSM12120G
12MM X 130	25	CSM12130G
12MM X 150	25	CSM12150G
12MM X 180	25	CSM12180G
12MM X 200	25	CSM12200G
12MM X 240	20	CSM12240G
12MM X 260	20	CSM12260G
12MM X 300	20	CSM12300G
16MM X 75	10	CSM1675G
16MM X 100	10	CSM16100G
16MM X 200	10	CSM16200G
16MM X 260	10	CSM16260G
20MM X 150	5	CSM20150G
20MM X 200	5	CSM20200G

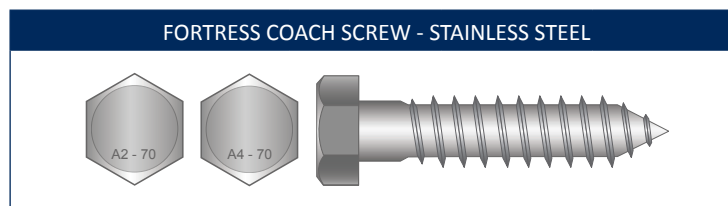

SIZE	PACK QTY	T304 (A2)	T316 (A4)
6MM X 40	50	CSXM640	CSXM640T
6MM X 50	50	CSXM650	CSXM650T
6MM X 65	50	CSXM665	CSXM665T
6MM X 75	50	CSXM675	CSXM675T
6MM X 80	50	CSXM680	CSXM680T
6MM X 90	50	CSXM690	CSXM690T
6MM X 100	50	CSXM6100	CSXM6100T
6MM X 130	100	CSXM6130	CSXM6130T
8MM X 30	25	CSXM830	CSXM830T
8MM X 40	25	CSXM840	CSXM840T
8MM X 50	25	CSXM850	CSXM850T
8MM X 60	25	CSXM860	CSXM860T
8MM X 65	25	CSXM865	CSXM865T
8MM X 75	25	CSXM875	CSXM875T
8MM X 80	25	CSXM880	CSXM880T
8MM X 100	25	CSXM8100	CSXM8100T
8MM X 120	25	CSXM8120	CSXM8120T
10MM X 40	25	CSXM1040	CSXM1040T
10MM X 50	25	CSXM1050	CSXM1050T
10MM X 65	25	CSXM1065	CSXM1065T
10MM X 70	25	CSXM1070	CSXM1070T
10MM X 75	25	CSXM1075	CSXM1075T
10MM X 80	25	CSXM1080	CSXM1080T
10MM X 90	25	CSXM1090	CSXM1090T
10MM X 100	25	CSXM10100	CSXM10100T
10MM X 120	25	CSXM10120	CSXM10120T
10MM X 130	25	CSXM10130	CSXM10130T
10MM X 150	25	CSXM10150	CSXM10150T
10MM X 180	25	CSXM10180	CSXM10180T
12MM X 50	25	CSXM1250	CSXM1250T
12MM X 65	25	CSXM1265	CSXM1265T
12MM X 70	25	CSXM1270	CSXM1270T
12MM X 75	25	CSXM1275	CSXM1275T
12MM X 80	25	CSXM1280	CSXM1280T
12MM X 90	25	CSXM1290	CSXM1290T
12MM X 100	25	CSXM12100	CSXM12100T
12MM X 120	25	CSXM12120	CSXM12120T
12MM X 130	25	CSXM12130	CSXM12130T
12MM X 150	25	CSXM12150	CSXM12150T
12MM X 180	10	CSXM12180	CSXM12180T
12MM X 200	10	CSXM12200	CSXM12200T
16MM X 75	10	CSXM1675	CSXM1675T
16MM X 130	10	CSXM16130	CSXM16130T

SET SCREWS

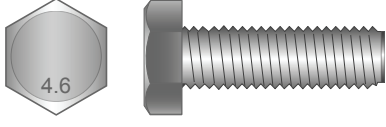
FORTRESS SET SCREWS - ZINC PLATED CLASS 4.6		
		
SIZE	PACK QTY	CODE
M4 X 50	200	SSM450Z
M5 X 10	200	SSM510Z
M5 X 12	200	SSM512Z
M5 X 20	200	SSM520Z
M5 X 25	200	SSM525Z
M5 X 30	150	SSM530Z
M6 X 12	200	SSM612Z
M6 X 16	200	SSM616Z
M6 X 20	200	SSM620Z
M6 X 25	200	SSM625Z
M6 X 30	150	SSM630Z
M6 X 35	150	SSM635Z
M6 X 40	150	SSM640Z
M6 X 50	150	SSM650Z
M6 X 65	100	SSM665Z
M8 X 12	125	SSM812Z
M8 X 16	125	SSM816Z
M8 X 20	100	SSM820Z
M8 X 25	100	SSM825Z
M8 X 30	75	SSM830Z
M8 X 35	75	SSM835Z
M8 X 40	75	SSM840Z
M8 X 45	50	SSM845Z
M8 X 50	50	SSM850Z
M8 X 65	50	SSM865Z
M8 X 75	50	SSM875Z
M10 X 12	100	SSM1012Z
M10 X 16	100	SSM1016Z
M10 X 20	100	SSM1020Z
M10 X 25	100	SSM1025Z
M10 X 30	100	SSM1030Z
M10 X 35	75	SSM1035Z
M10 X 40	75	SSM1040Z
M10 X 45	75	SSM1040Z
M10 X 50	75	SSM1050Z
M10 X 55	50	SSM1055Z
M10 X 60	50	SSM1060Z
M10 X 65	50	SSM1065Z
M10 X 75	50	SSM1075Z
M10 X 90	50	SSM1090Z
M10 X 100	50	SSM10100Z
M12 X 20	75	SSM1220Z
M12 X 25	75	SSM1225Z
M12 X 30	75	SSM1230Z

FORTRESS SET SCREWS - ZINC PLATED CLASS 4.6		
		
SIZE	PACK QTY	CODE
M12 X 35	50	SSM1235Z
M12 X 40	50	SSM1240Z
M12 X 45	50	SSM1245Z
M12 X 50	50	SSM1250Z
M12 X 60	25	SSM1260Z
M12 X 65	25	SM1265Z
M12 X 75	25	SSM1275Z
M12 X 100	25	SSM12100Z
M16 X 25	25	SSM1625Z
M16 X 30	25	SSM1630Z
M16 X 35	25	SSM1635Z
M16 X 40	25	SSM1640Z
M16 X 50	25	SSM1650Z
M16 X 75	25	SSM1675Z

FORTRESS SET SCREWS - ZINC PLATED CLASS 8.8

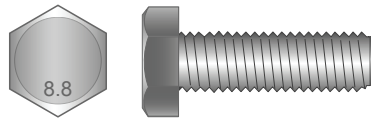

SIZE	PACK QTY	CODE
M6 X 12	200	SSHM612Z
M6 X 16	200	SSHM616Z
M6 X 20	200	SSHM620Z
M6 X 25	200	SSHM625Z
M6 X 30	200	SSHM630Z
M6 X 35	200	SSHM635Z
M6 X 40	200	SSHM640Z
M6 X 45	100	SSHM645Z
M6 X 50	100	SSHM650Z
M8 X 12	100	SSHM812Z
M8 X 16	100	SSHM816Z
M8 X 20	100	SSHM820Z
M8 X 25	100	SSHM825Z
M8 X 30	75	SSHM830Z
M8 X 35	75	SSHM835Z
M8 X 40	75	SSHM840Z
M8 X 45	75	SSHM845Z
M8 X 50	50	SSHM850Z
M8 X 90	50	SSHM890Z
M10 X 16	100	SSHM1016Z
M10 X 20	100	SSHM1020Z
M10 X 25	100	SSHM1025Z
M10 X 30	100	SSHM1030Z
M10 X 35	100	SSHM1035Z
M10 X 40	75	SSHM1040Z
M10 X 45	75	SSHM1045Z
M10 X 50	75	SSHM1050Z
M10 X 55	75	SSHM1055Z
M10 X 60	50	SSHM1060Z
M10 X 65	50	SSHM1065Z
M10 X 100	25	SSHM10100Z
M12 X 20	75	SSHM1220Z
M12 X 25	75	SSHM1225Z
M12 X 30	75	SSHM1230Z
M12 X 35	50	SSHM1235Z
M12 X 40	50	SSHM1240Z
M12 X 45	50	SSHM1245Z
M12 X 50	25	SSHM1250Z
M12 X 60	25	SSHM1260Z
M12 X 90	25	SSHM1290Z
M12 X 100	25	SSHM12100Z
M14 X 40	25	SSHM1440Z
M16 X 25	25	SSHM1625Z

FORTRESS SET SCREWS - ZINC PLATED CLASS 8.8

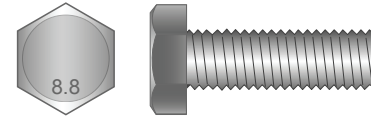

SIZE	PACK QTY	CODE
M16 X 30	25	SSHM1630Z
M16 X 35	25	SSHM1635Z
M16 X 40	25	SSHM1640Z
M16 X 50	25	SSHM1650Z

SET SCREWS - ZINC PLATED CLASS 8.8 METRIC FINE

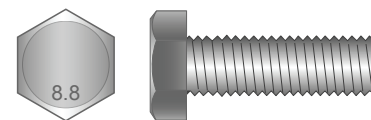

SIZE	PACK QTY	CODE	PITCH
M8 X 20	100	SSMF820Z	1.00
M8 X 25	100	SSMF825Z	1.00
M8 X 35	100	SSMF835Z	1.00
M8 X 40	100	SSMF840Z	1.00
M10 X 30	100	SSMF1030Z	1.25
M10 X 40	100	SSMF1040Z	1.25
M10 X 50	100	SSMF1050Z	1.25
M12 X 25	100	SSMF1225Z	1.25
M12 X 35	100	SSMF1235Z	1.25
M12 X 40	100	SSMF1240Z	1.25

FORTRESS SET SCREWS - STAINLESS STEEL

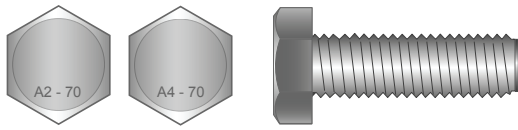

SIZE	PACK QTY	T304 (A2)	T316 (A4)
M4 X 8	200	SSXM48	SSXM48T
M4 X 20	200	SSXM420	SSXM420T
M4 X 25	200	SSXM425	SSXM425T
M4 X 30	200	SSXM430	SSXM430T
M4 X 35	200	SSXM435	SSXM435T
M5 X 8	200	SSXM58	SSXM58T
M5 X 10	200	SSXM510	SSXM510T
M5 X 12	200	SSXM512	SSXM512T
M5 X 16	200	SSXM516	SSXM516T
M5 X 20	200	SSXM520	SSXM520T
M5 X 25	200	SSXM525	SSXM525T
M5 X 30	100	SSXM530	SSXM530T
M5 X 40	100	SSXM540	SSXM540T
M5 X 50	50	SSXM550	SSXM550T
M6 X 10	200	SSXM610	SSXM610T
M6 X 12	200	SSXM612	SSXM612T
M6 X 16	200	SSXM616	SSXM616T
M6 X 20	200	SSXM620	SSXM620T
M6 X 25	200	SSXM625	SSXM625T
M6 X 30	200	SSXM630	SSXM630T
M6 X 35	200	SSXM635	SSXM635T
M6 X 40	200	SSXM640	SSXM640T
M6 X 45	100	SSXM645	SSXM645T
M6 X 50	100	SSXM650	SSXM650T
M6 X 60	100	SSXM660	SSXM660T
M6 X 65	100	SSXM665	SSXM665T
M6 X 70	100	SSXM670	SSXM670T
M6 X 75	100	SSXM675	SSXM675T
M8 X 12	100	SSXM812	SSXM812T
M8 X 16	100	SSXM816	SSXM816T
M8 X 20	100	SSXM820	SSXM820T
M8 X 25	100	SSXM825	SSXM825T
M8 X 30	100	SSXM830	SSXM830T
M8 X 35	100	SSXM835	SSXM835T
M8 X 40	100	SSXM840	SSXM840T
M8 X 45	100	SSXM845	SSXM845T
M8 X 50	100	SSXM850	SSXM850T
M8 X 55	100	SSXM855	SSXM855T
M8 X 60	100	SSXM860	SSXM860T
M8 X 70	100	SSXM870	SSXM870T
M8 X 80	100	SSXM880	SSXM880T
M8 X 90	100	SSXM890	SSXM890T

FORTRESS SET SCREWS - STAINLESS STEEL

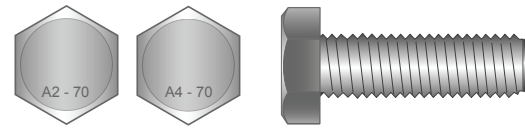

SIZE	PACK QTY	T304 (A2)	T316 (A4)
M10 X 16	100	SSXM1016	SSXM1016T
M10 X 20	100	SSXM1020	SSXM1020T
M10 X 25	100	SSXM1025	SSXM1025T
M10 X 30	100	SSXM1030	SSXM1030T
M10 X 35	100	SSXM1035	SSXM1035T
M10 X 45	100	SSXM1045	SSXM1045T
M10 X 40	100	SSXM1040	SSXM1040T
M10 X 50	100	SSXM1050	SSXM1050T
M10 X 55	50	SSXM1055	SSXM1055T
M10 X 65	50	SSXM1065	SSXM1065T
M10 X 80	50	SSXM1080	SSXM1080T
M12 X 20	100	SSXM1220	SSXM1220T
M12 X 25	50	SSXM1225	SSXM1225T
M12 X 30	100	SSXM1230	SSXM1230T
M12 X 35	100	SSXM1235	SSXM1235T
M12 X 40	100	SSXM1240	SSXM1240T
M12 X 45	50	SSXM1245	SSXM1245T
M12 X 50	50	SSXM1250	SSXM1250T
M12 X 55	50	SSXM1255	SSXM1255T
M12 X 60	50	SSXM1260	SSXM1260T
M12 X 65	50	SSXM1265	SSXM1265T
M12 X 70	50	SSXM1270	SSXM1270T
M12 X 75	50	SSXM1275	SSXM1275T
M12 X 80	25	SSXM1280T	SSXM1280T
M16 X 35	50	SSXM1635	SSXM1635T
M16 X 40	50	SSXM1640	SSXM1640T
M16 X 45	50	SSXM1645	SSXM1645T
M16 X 50	25	SSXM1650	SSXM1650T
M16 X 60	25	SSXM1660	SSXM1660T
M16 X 70	25	SSXM1670	SSXM1670T
M16 X 75	25	SSXM1675	SSXM1675T
M20 X 45	5	SSXM2045	SSXM2045T
M20 X 50	5	SSXM2050	SSXM2050T
M20 X 55	5	SSXM2055	SSXM2055T
M20 X 60	5	SSXM2060	SSXM2060T
M24 X 50	5	SSXM2450	SSXM2450T

FORTRESS SET SCREWS - STAINLESS STEEL UNC			
SIZE	PACK QTY	T304 (A2)	T316 (A4)
1/4 X 1/2"	100	SSX1412	SSX1412T
1/4 X 5/8"	100	SSX1458	SSX1458T
1/4 X 3/4"	100	SSX1434	SSX1434T
1/4 X 1"	100	SSX141	SSX141T
1/4 X 1 1/4"	100	SSX14114	SSX14114T
1/4 X 1 1/2"	100	SSX14112	SSX14112T
1/4 X 2"	100	SSX142	SSX142T
1/4 X 2 1/2"	50	SSX14212	SSX14212T
1/4 X 3"	50	SSX143	SSX143T
5/16 X 1/2"	100	SSX51612	SSX51612T
5/16 X 5/8"	100	SSX51658	SSX51658T
5/16 X 3/4"	100	SSX51634	SSX51634T
5/16 X 1"	100	SSX5161	SSX5161T
5/16 X 1 1/4"	100	SSX516114	SSX516114T
5/16 X 1 1/2"	100	SSX516112	SSX516112T
5/16 X 2"	100	SSX5162	SSX5162T
5/16 X 2 1/2"	50	SSX516212	SSX516212T
5/16 X 3"	50	SSX5163	SSX5163T
5/16 X 4"	50	SSX5164	SSX5164T
3/8 X 1/2"	100	SSX3812	SSX3812T
3/8 X 5/8"	100	SSX3858	SSX3858T
3/8 X 3/4"	100	SSX3834	SSX3834T
3/8 X 1"	100	SSX381	SSX381T
3/8 X 1 1/4"	100	SSX38114	SSX38114T
3/8 X 1 1/2"	100	SSX38112	SSX38112T
3/8 X 1 3/4"	100	SSX38134	SSX38134T
3/8 X 2"	100	SSX382	SSX382T
3/8 X 2 1/2"	50	SSX38212	SSX38212T
3/8 X 3"	50	SSX383	SSX383T
3/8 X 3 1/2"	50	SSX38312	SSX38312T
3/8 X 4"	50	SSX384	SSX384T
1/2 X 1"	100	SSX121	SSX121T
1/2 X 1 1/4"	100	SSX12114	SSX12114T
1/2 X 1 1/2"	50	SSX12112	SSX12112T
1/2 X 2"	50	SSX122	SSX122T
1/2 X 2 1/2"	50	SSX12212	SSX12212T
1/2 X 3"	50	SSX123	SSX123T
1/2 X 3 1/2"	50	SSX12312	SSX12312T
1/2 X 4"	25	SSX124	SSX124T
5/8 X 1"	25	SSX581	SSX581T
5/8 X 1 1/2"	25	SSX58112	SSX58112T
5/8 X 2"	25	SSX582	SSX582T

FORTRESS SET SCREWS - STAINLESS STEEL UNC			
SIZE	PACK QTY	T304 (A2)	T316 (A4)
5/8 X 2 1/2"	25	SSX58212	SSX58212T
5/8 X 3"	25	SSX583	SSX583T
5/8 X 4"	25	SSX584	SSX584T
3/4 X 1 1/2"	25	SSX34112	SSX34112T
3/4 X 1 3/4"	25	SSX34134	SSX34134T
3/4 X 2"	25	SSX342	SSX342T
3/4 X 2 1/2"	25	SSX34212	SSX34212T
3/4 X 3"	20	SSX343	SSX343T
3/4 X 4"	10	SSX344	SSX344T
7/8 X 2"	10	SSX782	SSX782T
7/8 X 2 1/2"	10	SSX78212	SSX78212T
7/8 X 3"	10	SSX783	SSX783T
1 X 2"	10	SSX12	SSX12T
1 X 2 1/2"	10	SSX1212	SSX1212T
1 X 3"	10	SSX13	SSX13T
1 X 3 1/2"	10	SSX1312	SSX1312T

All Stainless Steel stock is subject to availability at time of order

FORTRESS RAG BOLT & NUT - GALVANISED CLASS 4.6



SIZE	PACK QTY	CODE
M10 X 150	20	BRM10150G
M10 X 200	20	BRM10200G
M12 X 150	10	BRM12150G
M12 X 200	10	BRM12200G
M12 X 250	10	BRM12250G
M12 X 300	10	BRM12300G
M16 X 200	5	BRM16200G

FORTRESS CLOSED EYE BOLT - GALVANISED

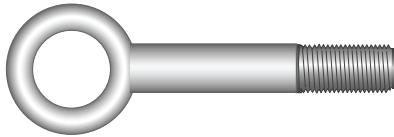

SIZE	PACK QTY	CODE
M12 X 150	10	BEYEM12150G
M12 X 180	10	BEYEM12180G
M12 X 200	10	BEYEM12200G
M12 X 250	10	BEYEM12250G

JOINT CONNECTOR BOLTS

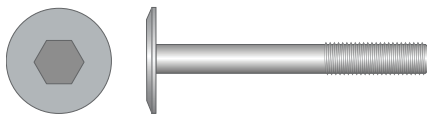

SIZE	PACK QTY	CODE	FINISH
M6 X 50	100		Z/C
M6 X 60	100		Z/C
M6 X 70	100		Z/C
M6 X 25	100		T304
M6 X 35	100		T304
M6 X 40	100		T304
M6 X 50	100		T304
M6 X 60	100		T304
M6 X 70	100		T304

*Other sizes available upon request

FORTRESS GUTTER BOLTS & NUTS - ZINC PLATED

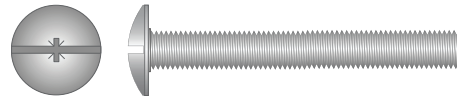

SIZE	PACK QTY	CODE
M5 X 10	100	GBNM510ZJ
M5 X 12	100	GBNM512ZJ
M5 X 16	100	GBNM516ZJ
M5 X 20	100	GBNM520ZJ
M5 X 25	100	GBNM525ZJ
M5 X 30	100	GBNM530ZJ
M5 X 40	100	GBNM540ZJ
M5 X 50	100	GBNM550ZJ
M5 X 60	50	GBNM560ZJ
M5 X 80	50	GBNM580ZJ
M6 X 12	100	GBNM612ZJ
M6 X 16	100	GBNM616ZJ
M6 X 20	100	GBNM620ZJ
M6 X 25	100	GBNM625ZJ
M6 X 30	100	GBNM630ZJ
M6 X 35	100	GBNM635ZJ
M6 X 40	50	GBNM640ZJ
M6 X 45	50	GBNM645ZJ
M6 X 50	50	GBNM650ZJ
M6 X 60	50	GBNM660ZJ
M6 X 80	25	GBNM680ZJ

UNC & UNF ENGINEERS BOLT & NUT

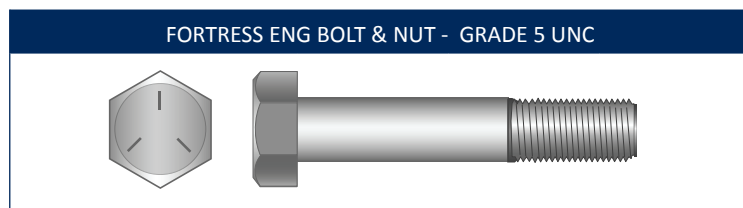

SIZE	PACK QTY	BLACK	ZINC
1/4 X 1/2"	200	BNC1412B	BNC1412Z
1/4 X 3/4"	200	BNC1434B	BNC1434Z
1/4 X 1"	200	BNC141B	BNC141Z
1/4 X 1 1/4"	200	BNC14114B	BNC14114Z
1/4 X 1 1/2"	200	BNC14112B	BNC14112Z
1/4 X 1 3/4"	200	BNC14134B	BNC14134Z
1/4 X 2"	200	BNC142B	BNC142Z
1/4 X 2 1/2"	150	BNC14212B	BNC14212Z
1/4 X 3"	150	BNC143B	BNC143Z
1/4 X 3 1/2"	150	BNC14312B	BNC14312Z
1/4 X 4"	150	BNC144B	BNC144Z
1/4 X 4 1/2"	150	BNC14412B	BNC14412Z
5/16 X 3/4"	200	BNC51634B	BNC51634Z
5/16 X 1"	200	BNC5161B	BNC5161Z
5/16 X 1 1/4"	200	BNC516114B	BNC516114Z
5/16 X 1 1/2"	200	BNC516112B	BNC516112Z
5/16 X 1 3/4"	150	BNC516134B	BNC516134Z
5/16 X 2"	150	BNC5162B	BNC5162Z
5/16 X 2 1/4"	150	BNC516214B	BNC516214Z
5/16 X 2 1/2"	150	BNC516212B	BNC516212Z
5/16 X 2 3/4"	100	BNC516234B	BNC516234Z
5/16 X 3"	100	BNC5163B	BNC5163Z
5/16 X 3 1/2"	100	BNC516312B	BNC516312Z
5/16 X 4"	100	BNC5164B	BNC5164Z
5/16 X 4 1/2"	100	BNC516412B	BNC516412Z
5/16 X 5"	100	BNC5165B	BNC5165Z
5/16 X 6"	100	BNC5166B	BNC5166Z
3/8 X 3/4"	200	BNC3834B	BNC3834Z
3/8 X 1"	200	BNC381B	BNC381Z
3/8 X 1 1/4"	200	BNC38114B	BNC38114Z
3/8 X 1 1/2"	150	BNC38112B	BNC38112Z
3/8 X 1 3/4"	150	BNC38134B	BNC38134Z
3/8 X 2"	100	BNC382B	BNC382Z
3/8 X 2 1/4"	100	BNC38214B	BNC38214Z
3/8 X 2 1/2"	100	BNC38212B	BNC38212Z
3/8 X 2 3/4"	100	BNC38234B	BNC38234Z
3/8 X 3"	100	BNC383B	BNC383Z

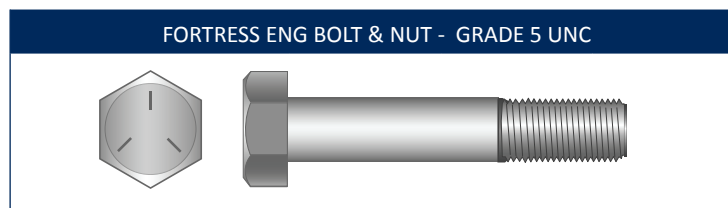

SIZE	PACK QTY	BLACK	ZINC
3/8 X 3 1/2"	50	BNC38312B	BNC38312Z
3/8 X 4"	50	BNC384B	BNC384Z
3/8 X 4 1/2"	50	BNC38412B	BNC38412Z
3/8 X 5"	50	BNC385B	BNC385Z
3/8 X 5 1/2"	50	BNC38512B	BNC38512Z
3/8 X 6"	50	BNC386B	BNC386Z
7/16 X 1"	100	BNC7161B	BNC7161Z
7/16 X 1 1/4"	100	BNC716114B	BNC716114Z
7/16 X 1 1/2"	100	BNC716112B	BNC716112Z
7/16 X 1 3/4"	100	BNC716134B	BNC716134Z
7/16 X 2"	100	BNC7162B	BNC7162Z
7/16 X 2 1/4"	75	BNC716214B	BNC716214Z
7/16 X 2 1/2"	75	BNC716212B	BNC716212Z
7/16 X 2 3/4"	75	BNC716234B	BNC716234Z
7/16 X 3"	75	BNC7163B	BNC7163Z
7/16 X 3 1/2"	75	BNC716312B	BNC716312Z
7/16 X 4"	50	BNC7164B	BNC7164Z
7/16 X 4 1/2"	50	BNC716412B	BNC716412Z
7/16 X 5"	50	BNC7165B	BNC7165Z
7/16 X 5 1/2"	50	BNC716512B	BNC716512Z
7/16 X 6"	50	BNC7166B	BNC7166Z

*Minimum quantities may apply on some Zinc plated bolts.

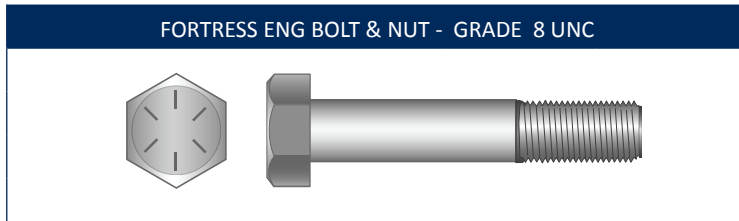

SIZE	PACK QTY	BLACK	ZINC
1/2 X 3/4"	22	BNC1234	BNC1234Z
1/2 X 1"	25	BNC121	BNC121Z
1/2 X 1 1/4"	25	BNC12114	BNC12114Z
1/2 X 1 1/2"	25	BNC12112	BNC12112Z
1/2 X 1 3/4"	25	BNC12134	BNC12134Z
1/2 X 2"	25	BNC122	BNC122Z
1/2 X 2 1/4"	25	BNC12214	BNC12214Z
1/2 X 2 1/2"	25	BNC12212	BNC12212Z
1/2 X 2 3/4"	25	BNC12234	BNC12234Z
1/2 X 3"	25	BNC123	BNC123Z
1/2 X 3 1/4"	25	BNC12314	BNC12314Z
1/2 X 3 1/2"	25	BNC12312	BNC12312Z
1/2 X 3 3/4"	25	BNC12334	BNC12334Z
1/2 X 4"	25	BNC124	BNC124Z
1/2 X 4 1/2"	25	BNC12412	BNC12412Z
1/2 X 5"	25	BNC125	BNC125Z
1/2 X 5 1/2"	25	BNC12512	BNC12512Z
1/2 X 6"	25	BNC126	BNC126Z
1/2 X 6 1/2"	25	BNC12612	BNC12612Z
1/2 X 7"	25	BNC127	BNC127Z
1/2 X 7 1/2"	25	BNC12712	BNC12712Z
1/2 X 8"	25	BNC128	BNC128Z
1/2 X 8 1/2"	25	BNC12812	BNC12812Z
3/4 X 1 1/2"	25	BNC34112B	BNC34112Z
3/4 X 1 3/4"	25	BNC34134B	BNC34134Z
3/4 X 2"	25	BNC342B	BNC342Z
3/4 X 2 1/4"	25	BNC34214B	BNC34214Z
3/4 X 2 1/2"	20	BNC34212B	BNC34212Z
3/4 X 2 3/4"	20	BNC34234B	BNC34234Z
3/4 X 3"	20	BNC343B	BNC343Z
3/4 X 3 1/2"	20	BNC34312B	BNC34312Z
3/4 X 4"	10	BNC344B	BNC344Z
3/4 X 4 1/2"	10	BNC34412B	BNC34412Z
3/4 X 5"	10	BNC345B	BNC345Z
3/4 X 5 1/2"	10	BNC34512B	BNC34512Z
3/4 X 6"	10	BNC346B	BNC346Z
3/4 X 6 1/2"	10	BNC34612B	BNC34612Z
3/4 X 7"	10	BNC347B	BNC347Z
3/4 X 7 1/2"	10	BNC34712B	BNC34712Z
3/4 X 8"	10	BNC348B	BNC348Z
3/4 X 9"	5	BNC349B	BNC349Z

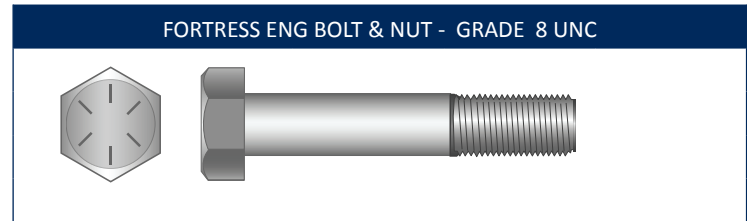

SIZE	PACK QTY	BLACK	ZINC
3/4 X 10"	5	BNC3410B	BNC3410Z
7/8 X 2"	10	BNC782B	BNC782Z
7/8 X 2 1/4"	10	BNC78214B	BNC78214Z
7/8 X 2 1/2"	10	BNC78212B	BNC78212Z
7/8 X 3"	10	BNC783B	BNC783Z
7/8 X 3 1/2"	10	BNC78312B	BNC78312Z
7/8 X 4"	10	BNC784B	BNC784Z
7/8 X 4 1/2"	10	BNC78412B	BNC78412Z
7/8 X 5"	10	BNC785B	BNC785Z
7/8 X 5 1/2"	10	BNC78512B	BNC78512Z
7/8 X 6"	10	BNC786B	BNC786Z
7/8 X 6 1/2"	5	BNC78612B	BNC78612Z
7/8 X 7"	5	BNC787B	BNC787Z
7/8 X 8"	5	BNC788B	BNC788Z
7/8 X 9"	5	BNC789B	BNC789Z
7/8 X 10"	5	BNC7810B	BNC7810Z
1 X 2"	5	BNC12B	BNC12Z
1 X 2 1/2"	5	BNC1212B	BNC1212Z
1 X 3"	5	BNC13B	BNC13Z
1 X 3 1/2"	5	BNC1312B	BNC1312Z
1 X 4"	5	BNC14B	BNC14Z
1 X 4 1/2"	5	BNC1412B	BNC1412Z
1 X 5"	5	BNC15B	BNC15Z
1 X 6 1/2"	5	BNC1612B	BNC1612Z
1 X 7"	5	BNC17B	BNC17Z
1 X 7 1/2"	5	BNC1712B	BNC1712Z
1 X 8"	5	BNC18B	BNC18Z
1 X 8 1/2"	5	BNC1812B	BNC1812Z
1 X 9"	5	BNC19B	BNC19Z
1 X 10"	5	BNC110B	BNC110Z
1.1/8 X 3"	5	BNC1183B	BNC1183Z
1.1/8 X 3 1/2"	5	BNC118312B	BNC118312Z
1.1/8 X 4"	5	BNC1184B	BNC1184Z
1.1/8 X 4 1/2"	5	BNC118412B	BNC118412Z
1.1/8 X 5"	5	BNC1185B	BNC1185Z
1.1/8 X 6"	5	BNC1186B	BNC1186Z
1.1/8 X 8"	5	BNC1188B	BNC1188Z
1.1/8 X 9"	5	BNC1189B	BNC1189Z
1.1/8 X 10"	5	BNC11810B	BNC11810Z
1.1/4 X 3"	4	BNC1143B	BNC1143Z
1.1/4 X 3 1/2"	4	BNC114312B	BNC114312Z

FORTRESS ENG BOLT & NUT - GRADE 8 UNC



SIZE	PACK QTY	BLACK	ZINC
1.1/4 X 4"	4	BNC1144B	BNC1144Z
1.1/4 X 4 1/2"	4	BNC114412B	BNC114412Z
1.1/4 X 5"	4	BNC1145B	BNC1145Z
1.1/4 X 5 1/2"	4	BNC114512B	BNC114512Z
1.1/4 X 6"	4	BNC1146B	BNC1146Z
1.1/4 X 7"	4	BNC1147B	BNC1147Z
1.1/4 X 8"	4	BNC1148B	BNC1148Z
1.1/4 X 9"	4	BNC1149B	BNC1149Z
1.1/4 X 10"	4	BNC11410B	BNC11410Z
1.1/2 X 4"	3	BNC1124B	BNC1124Z
1.1/2 X 5"	3	BNC1125B	BNC1125Z
1.1/2 X 6"	3	BNC1126B	BNC1126Z
1 1/2 X 7"	3	BNC1127B	BNC1127Z
1.1/2 X 8"	3	BNC1128B	BNC1128Z

*Minimum quantities may apply on some Zinc plated bolts.

LEADING SOLUTIONS FOR INDUSTRY

southco[®]
AUTHORISED DISTRIBUTOR



Panel/Door Latches and Locks Electronic Access Solutions
 Quick Access Fasteners Captive Screws
 Hinges/Position Control Handles
 Inject/Eject Mechanisms Inserts and Standoffs
 Marine Deck Hardware

■ POSITION IT ■ SEAL IT ■ CONTROL IT ■ SECURE IT ■ COMPRESS IT

FORTRESS ENG BOLT & NUT - GRADE 5 UNF



SIZE	PACK QTY	BLACK	ZINC
1/4 X 3/4"	200	BNF1434B	BNF1434Z
1/4 X 1"	200	BNF141B	BNF141Z
1/4 X 1 1/4"	200	BNF14114B	BNF14114Z
1/4 X 1 1/2"	200	BNF14112B	BNF14112Z
1/4 X 2"	200	BNF142B	BNF142Z
1/4 X 2 1/2"	150	BNF14212B	BNF14212Z
1/4 X 3"	150	BNF143B	BNF143Z
1/4 X 4"	150	BNF144B	BNF144Z
5/16 X 3/4"	200	BNF51634B	BNF51634Z
5/16 X 1"	200	BNF5161B	BNF5161Z
5/16 X 1 1/4"	200	BNF516114B	BNF516114Z
5/16 X 1 1/2"	200	BNF516112B	BNF516112Z
5/16 X 2"	150	BNF5162B	BNF5162Z
5/16 X 2 1/2"	150	BNF516212B	BNF516212Z
5/16 X 3"	100	BNF5163B	BNF5163Z
5/16 X 3 1/2"	100	BNF516312B	BNF516312Z
5/16 X 4"	100	BNF5164B	BNF5164Z
5/16 X 6"	100	BNF5166B	BNF5166Z
3/8 X 3/4"	200	BNF3834B	BNF3834Z
3/8 X 1"	200	BNF381B	BNF381Z
3/8 X 1 1/4"	200	BNF38114B	BNF38114Z
3/8 X 1 1/2"	150	BNF38112B	BNF38112Z
3/8 X 1 3/4"	150	BNF38134B	BNF38134Z
3/8 X 2"	100	BNF382B	BNF382Z
3/8 X 2 1/4"	100	BNF38214B	BNF38214Z
3/8 X 2 1/2"	100	BNF38212B	BNF38212Z
3/8 X 3"	100	BNF383B	BNF383Z
3/8 X 3 1/2"	50	BNF38312B	BNF38312Z
3/8 X 4"	50	BNF384B	BNF384Z
3/8 X 4 1/2"	50	BNF38412B	BNF38412Z
3/8 X 5"	50	BNF385B	BNF385Z
7/16 X 1"	100	BNF7161B	BNF7161Z
7/16 X 1 1/4"	100	BNF716114B	BNF716114Z
7/16 X 1 1/2"	100	BNF716112B	BNF716112Z
7/16 X 2"	100	BNF7162B	BNF7162Z
7/16 X 2 1/2"	75	BNF716212B	BNF716212Z
7/16 X 3"	75	BNF7163B	BNF7163Z
7/16 X 3 1/2"	75	BNF716312B	BNF716312Z
7/16 X 4"	50	BNF7164B	BNF7164Z
7/16 X 4 1/2"	50	BNF716412B	BNF716412Z
7/16 X 5"	50	BNF7165B	BNF7165Z

FORTRESS ENG BOLT & NUT - GRADE 8 UNF



SIZE	PACK QTY	BLACK	ZINC
1/2 X 3/4"	75	BNF1234B	BNF1234Z
1/2 X 1"	75	BNF121B	BNF121Z
1/2 X 1 1/4"	75	BNF12114B	BNF12114Z
1/2 X 1 1/2"	75	BNF12112B	BNF12112Z
1/2 X 1 3/4"	75	BNF12134B	BNF12134Z
1/2 X 2"	50	BNF122B	BNF122Z
1/2 X 2 1/4"	50	BNF12214B	BNF12214Z
1/2 X 2 1/2"	50	BNF12214B	BNF12214Z
1/2 X 2 3/4"	50	BNF12234B	BNF12234Z
1/2 X 3"	25	BNF123B	BNF123Z
1/2 X 3 1/2"	25	BNF12312B	BNF12312Z
1/2 X 4"	25	BNF124B	BNF124Z
1/2 X 4 1/2"	25	BNF12412B	BNF12412Z
1/2 X 5"	25	BNF125B	BNF125Z
1/2 X 5 1/2"	25	BNF12512B	BNF12512Z
1/2 X 6"	25	BNF126B	BNF126Z
1/2 X 6 1/2"	20	BNF12612B	BNF12612Z
1/2 X 7"	20	BNF127B	BNF127Z
1/2 X 8"	20	BNF128B	BNF128Z
9/16 X 1 1/2"	25	BNF916112B	BNF916112Z
9/16 X 2"	25	BNF9162B	BNF9162Z
9/16 X 2 1/2"	25	BNF916212B	BNF916212Z
9/16 X 3"	25	BNF9163B	BNF9163Z
9/16 X 3 1/2"	25	BNF916312B	BNF916312Z
9/16 X 4"	25	BNF9164B	BNF9164Z
5/8 X 1"	25	BNF581B	BNF581Z
5/8 X 1 1/4"	25	BNF58114B	BNF58114Z
5/8 X 1 1/2"	25	BNF58112B	BNF58112Z
5/8 X 1 3/4"	25	BNF58134B	BNF58134Z
5/8 X 2"	25	BNF582B	BNF582Z
5/8 X 2 1/4"	25	BNF58214B	BNF58214Z
5/8 X 2 1/2"	25	BNF58212B	BNF58212Z
5/8 X 2 3/4"	25	BNF58234B	BNF58234Z
5/8 X 3"	25	BNF583B	BNF583Z
5/8 X 3 1/2"	25	BNF58312B	BNF58312Z
5/8 X 4"	25	BNF584B	BNF584Z
5/8 X 4 1/2"	15	BNF58412B	BNF58412Z
5/8 X 5"	15	BNF585B	BNF585Z
5/8 X 5 1/2"	15	BNF58512B	BNF58512Z
5/8 X 6"	15	BNF586B	BNF586Z
5/8 X 6 1/2"	15	BNF58612B	BNF58612Z

STRUCTURAL FASTENERS

FORTRESS HSFG BOLT/NUT/WASHER CLASS 8.8 - GALVANISED

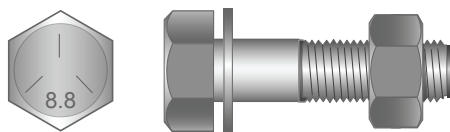

SIZE	PACK QTY	CODE
M16 X 40	EACH	BNHSFGM1640G
M16 X 45	EACH	BNHSFGM1645G
M16 X 50	EACH	BNHSFGM1650G
M16 X 55	EACH	BNHSFGM1655G
M16 X 60	EACH	BNHSFGM1660G
M16 X 65	EACH	BNHSFGM1665G
M16 X 70	EACH	BNHSFGM1670G
M16 X 75	EACH	BNHSFGM1675G
M16 X 80	EACH	BNHSFGM1680G
M16 X 90	EACH	BNHSFGM1690G
M16 X 100	EACH	BNHSFGM16100G
M16 X 110	EACH	BNHSFGM16110G
M16 X 120	EACH	BNHSFGM16120G
M16 X 130	EACH	BNHSFGM16130G
M16 X 140	EACH	BNHSFGM16140G
M16 X 150	EACH	BNHSFGM16150G
M16 X 180	EACH	BNHSFGM16180G
M16 X 200	EACH	BNHSFGM16200G
M20 X 40	EACH	BNHSFGM2040G
M20 X 45	EACH	BNHSFGM2045G
M20 X 50	EACH	BNHSFGM2050G
M20 X 55	EACH	BNHSFGM2055G
M20 X 60	EACH	BNHSFGM2060G
M20 X 65	EACH	BNHSFGM2065G
M20 X 70	EACH	BNHSFGM2070G
M20 X 80	EACH	BNHSFGM2080G
M20 X 90	EACH	BNHSFGM2009G
M20 X 100	EACH	BNHSFGM20100G
M20 X 110	EACH	BNHSFGM20110G
M20 X 120	EACH	BNHSFGM20120G
M20 X 130	EACH	BNHSFGM20130G
M20 X 140	EACH	BNHSFGM20140G

FORTRESS HSFG BOLT/NUT/WASHER CLASS 8.8 - GALVANISED

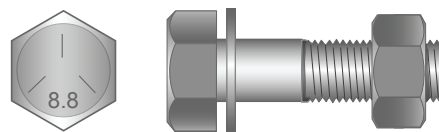

SIZE	PACK QTY	CODE
M20 X 150	EACH	BNHSFGM20150G
M20 X 200	EACH	BNHSFGM20200G
M24 X 50	EACH	BNHSFGM2450G
M24 X 55	EACH	BNHSFGM2455G
M24 X 60	EACH	BNHSFGM2460G
M24 X 65	EACH	BNHSFGM2465G
M24 X 70	EACH	BNHSFGM2470G
M24 X 75	EACH	BNHSFGM2475G
M24 X 80	EACH	BNHSFGM2480G
M24 X 85	EACH	BNHSFGM2485G
M24 X 90	EACH	BNHSFGM2490G
M24 X 100	EACH	BNHSFGM24100G
M24 X 110	EACH	BNHSFGM24110G
M24 X 120	EACH	BNHSFGM24120G
M24 X 130	EACH	BNHSFGM24130G
M24 X 150	EACH	BNHSFGM24150G
M24 X 160	EACH	BNHSFGM24160G
M24 X 180	EACH	BNHSFGM24180G
M30 X 75	EACH	BNHSFGM3075G
M30 X 80	EACH	BNHSFGM3080G
M30 X 90	EACH	BNHSFGM3090G
M30 X 100	EACH	BNHSFGM30100G
M30 X 110	EACH	BNHSFGM30110G
M30 X 120	EACH	BNHSFGM30120G
M30 X 130	EACH	BNHSFGM30130G
M30 X 150	EACH	BNHSFGM30150G
M36 X 90	EACH	BNHSFGM3690G
M36 X 100	EACH	BNHSFGM36100G
M36 X 120	EACH	BNHSFGM36120G
M36 X 130	EACH	BNHSFGM36130G
M36 X 140	EACH	BNHSFGM36140G
M36 X 150	EACH	BNHSFGM36150G

DESIGNED FOR YOUR INDUSTRY



Full stock range available

FORTRESS HSMG NUTS 8.8 - GALVANISED		
		
SIZE	PACK QTY	CODE
M16	50	NHSFGM16G
M20	50	NHSFGM20G
M22	25	NHSFGM22G
M24	25	NHSFGM24G
M30	25	NHSFGM30G
M36	25	NHSFGM36G

FORTRESS HSMG WASHERS 8.8 - GALVANISED		
		
SIZE	PACK QTY	CODE
M16	100	WHSFGM16G
M20	50	WHSFGM20G
M22	50	WHSFGM22G
M24 BLACK	50	WHSFGM24B
M24	50	WHSFGM24G
M30	50	WHSFGM30G
M36	50	WHSFGM36G

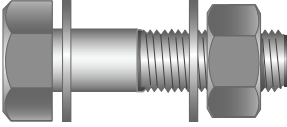
FORTRESS GALV ASSEMBLIES - CLASS 4.6		
 		
SIZE	PACK QTY	CODE
M12 X 30	EACH	BNM1230GA
M12 X 35	EACH	BNM1235A
M12 X 40	EACH	BNM1240GA
M12 X 50	EACH	BNM1250GA
M16 X 30	EACH	BNM1630GA
M16 X 35	EACH	BNM1635GA
M16 X 40	EACH	BNM1640GA
M16 X 45	EACH	BNM1645GA
M16 X 50	EACH	BNM1650GA
M16 X 80	EACH	BNM1680GA
M20 X 70	EACH	BNM2070GA
M20 X 90	EACH	BNM2090GA

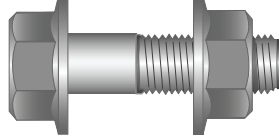
FORTRESS PURLIN FLANGE ASSEMBLIES - CLASS 4.6			
 			
SIZE	PACK QTY	CODE	FINISH
M12 X 30	EACH	BNM1230PG	GALV
M12 X 30	EACH	BNM1230PZ	ZINC
M16 X 35	EACH	BNM1635PG	GALV
M16 X 35	EACH	BNM1635PZ	ZINC

QUALITY APPROVED



Cutting & Grinding Discs Flap Discs Fibre Discs
 Flap Wheels Powerfile Belts Wire Wheels & Brushes
 Grinding Wheels Polishing Compounds

THREADED ROD

THREADED ROD - GALV CLASS 4.6	
	
SIZE	CODE
M8 X 1 METRE	TRM8G
M10 X 1 METRE	TRM10G
M10 X 2 METRE	TRM102G
M12 X 1 METRE	TRM12G
M12 X 2 METRE	TRM122G
M16 X 1 METRE	TRM16G
M16 X 2 METRE	TRM162G
M16 X 3 METRE	TRM163G
M20 X 1 METRE	TRM20G
M20 X 3 METRE	TRM203G
M24 X 1 METRE	TRM24G
M30 X 1 METRE	TRM30G

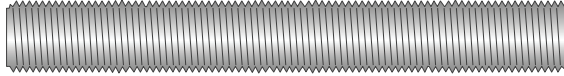
THREADED ROD - GALV CLASS 8.8	
	
SIZE	CODE
M12 X 1 METRE	TRM12HG
M12 X 3 METRE	TRM123HG
M16 X 1 METRE	TRM16HG
M16 X 3 METRE	TRM163HG
M20 X 1 METRE	TRM20HG
M20 X 3 METRE	TRM203HG
M24 X 1 METRE	TRM24HG
M24 X 3 METRE	TRM243HG
M30 X 1 METRE	TRM30HG
M30 X 3 METRE	TRM303HG
M36 X 1 METRE	TRM36HG

THREADED ROD - ZINC PLATED CLASS 4.6	
	
SIZE	CODE
M4 X 1 METRE	TRM4Z
M5 X 1 METRE	TRM5Z
M6 X 1 METRE	TRM6Z
M6 X 2 METRE	TRM62Z
M8 X 1 METRE	TRM8Z
M8 X 2 METRE	TRM82Z
M10 X 1 METRE	TRM10Z
M10 X 2 METRE	TRM102Z
M10 X 3 METRE	TRM103Z
M12 X 1 METRE	TRM12Z
M12 X 2 METRE	TRM122Z
M12 X 3 METRE	TRM123Z
M14 X 1 METRE	TRM14Z
M16 X 1 METRE	TRM16Z
M16 X 2 METRE	TRM162Z
M20 X 1 METRE	TRM20Z
M24 X 1 METRE	TRM24Z
M30 X 1 METRE	TRM30Z

FORTRESS THREADED ROD - ZINC PLATED CLASS 8.8	
	
SIZE	CODE
M6 X 1 METRE	TRM6HZ
M8 X 1 METRE	TRM8HZ
M10 X 1 METRE	TRM10HZ
M12 X 1 METRE	TRM12HZ
M16 X 1 METRE	TRM16HZ
M20 X 1 METRE	TRM20HZ
M24 X 1 METRE	TRM24HZ
M30 X 1 METRE	TRM30HZ

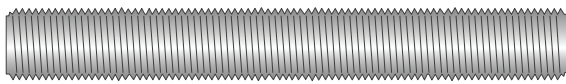
THREADED ROD - STAINLESS STEEL		
		
SIZE	T304 (A2)	T316 (A4)
M3 X 1 METRE		TRXM3T
M4 X 1 METRE	TRXM4	TRXM4T
M5 X 1 METRE	TRXM5	TRXM5T
M6 X 1 METRE	TRXM6	TRXM6T
M8 X 1 METRE	TRXM8	TRXM8T
M10 X 1 METRE	TRXM10	TRXM10T
M12 X 1 METRE	TRXM12	TRXM12T
M12 X 2 METRE		TRXM122T
M16 X 1 METRE	TRXM16	TRXM16T
M16 X 2 METRE		TRXM162T
M20 X 1 METRE	TRXM20	TRXM20T
M20 X 2 METRE		TRXM202T
M24 X 1 METRE	TRXM24	TRXM24T
M30 X 1 METRE		TRXM30T

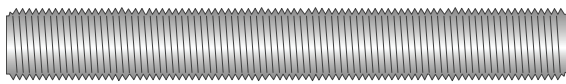
THREADED ROD - STAINLESS STEEL IMPERIAL		
		
SIZE	T304 (A2)	T316 (A4)
1" X 3FT	TRX1	TRX1T
1/2" X 3FT	TRX12	TRX12T
1/4" X 3FT	TRX14	TRX14T
3/16" X 3FT	TRX316	TRX316T
3/4" X 3FT	TRX34	TRX34T
3/8" X 3FT	TRX38	TRX38T
5/16" X 3FT	TRX516	TRX516T
5/8" X 3 FT	TRX58	TRX58T

* Stud cutting service available.
Contact your Account Manager for information

FORTRESS COUPLING NUTS - ZINC		
		
SIZE	PACK QTY	CODE
M6	EACH	NCM6Z
M8	EACH	NCM8Z
M10	EACH	NCM10Z
M12	EACH	NCM12Z
M16	EACH	NCM16Z
M20	EACH	NCM20Z
M24	EACH	NCM24Z

FORTRESS COUPLING NUTS - GALVANISED		
		
SIZE	PACK QTY	CODE
M10	EACH	NCM10G
M12	EACH	NCM12G
M16	EACH	NCM16G
M20	EACH	NCM20G
M24	EACH	NCM24G

FORTRESS COUPLING NUTS - STAINLESS STEEL T316		
		
SIZE	PACK QTY	CODE
M6	EACH	NCXM6T
M10	EACH	NCXM10T
M12	EACH	NCXM12T

SPECIFICATION SHEET

Steel Hex Head Bolt & Nut METRIC COURSE

BOLTS MANUFACTURED TO: AS 1111 METRIC SERIES 4.6
: AS 1110 METRIC SERIES 8.8
NUTS MANUFACTURED TO : AS 1112 METRIC SERIES 8.8

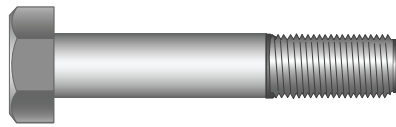

SIZE	PITCH Distance between threads(mm)	AF Head Diameter (mm)	THREAD LENGTH (NOMINAL)		
			Up to 125mm	Over 125 to 20mm	Over 200mm
M6	1.00mm	10mm	18mm	24mm	
M8	1.25mm	13mm	22mm	28mm	
M10	1.50mm	16mm	26mm	32mm	45mm
M12	1.75mm	18mm	30mm	36mm	49mm
M16	2.00mm	24mm	38mm	44mm	57mm
M20	2.50mm	30mm	46mm	52mm	65mm
M24	3.00mm	36mm	54mm	60mm	73mm

RECOMMENDED TIGHTENING TORQUE		
SIZE	CLASS 4.6	CLASS 8.8
M6	3.5 Nm	9 Nm
M8	8.5 Nm	22 Nm
M10	17 Nm	44 Nm
M12	30 Nm	77 Nm
M16	73 Nm	190 Nm
M20	143 Nm	370 Nm
M24	248 Nm	640 Nm

BREAKING LOAD OF BOLT		
SIZE	CLASS 4.6	CLASS 8.8
M6	8.0 kN	16.1 kN
M8	14.6 kN	29.2 kN
M10	23.2 kN	46.4 kN
M12	33.7 kN	67.4 kN

SPECIFICATION SHEET

Steel Hex Head Bolt & Nut

UNIFIED NATIONAL FINE & COURSE

MANUFACTURED TO AS 2465
 BOLTS: DIMENSIONS TO ANSI/ASME B18.2.1
 NUTS: DIMENSIONS TO ANSI/ASME B18.2.2



SIZE	THREADS PER INCH (TPI)		ACROSS FLATS (AF)
	UNF	UNC	HEAD DIAMETER - INCH
1/4"	28	20	0.438
5/16"	24	18	0.500
3/8"	24	16	0.562
7/16"	20	14	0.625
1/2"	20	13	0.750
9/16"	18	12	0.875
5/8"	18	11	0.938
3/4"	16	10	1.125

RECOMMENDED TIGHTENING TORQUE			
	SIZE	UNF	UNC
GRADE 5	1/4"	11 Nm	9 Nm
	5/16"	23 Nm	20 Nm
	3/8"	40 Nm	36 Nm
	7/16"	65 Nm	58 Nm
GRADE 8	1/2"	141 Nm	124 Nm
	5/8"	280 Nm	247 Nm
	3/4"	491 Nm	440 Nm

BREAKING LOAD OF BOLT (MINIMUM)			
	SIZE	UNF	UNC
GRADE 5	1/4"	19 kN	17 kN
	5/16"	31 kN	28 kN
	3/8"	46 kN	41 kN
	7/16"	63 kN	57 kN

SPECIFICATION SHEET

Stainless Steel Hex Head Bolt/nut - Set Screws METRIC COURSE

BOLTS MANUFACTURED TO: AS 1111 METRIC SERIES 4.6
 : AS 1110 METRIC SERIES 8.8
 NUTS MANUFACTURED TO : AS 1112 METRIC SERIES 8.8

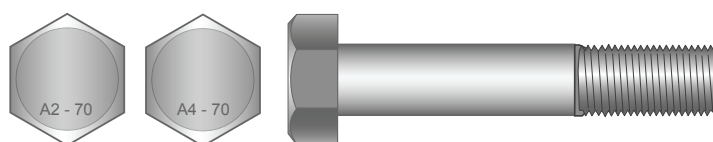

SIZE	PITCH	AF
	Distance between threads(mm)	Head Diameter (mm)
M6	1.00mm	10mm
M8	1.25mm	13mm
M10	1.50mm	16mm
M12	1.75mm	18mm
M16	2.00mm	24mm
M20	2.50mm	30mm
M24	3.00mm	36mm

CHEMICAL TYPICAL COMPOSITION	
T304 (A2)	T316
CHROMIUM 18%	CHROMIUM 18%
NICKEL 18%	NICKEL 18%
	MOLYBDENUM 2.2%

RECOMMENDED TIGHTENING TORQUE	
SIZE	
M6	7.0 Nm
M8	18 Nm
M10	35 Nm
M12	60 Nm
M16	152 Nm
M20	295 Nm

BREAKING LOAD OF BOLT (minimum)	
SIZE	
M6	9.0 kN
M8	17 kN
M10	26 kN
M12	37 kN
M16	70 kN
M20	110 kN

SPECIFICATION SHEET

High Strength Friction Grip

Bolts, Nuts and Washers

Manufactured to AS 1252 - 1983 Dimensions

AS 1252 - 1996 Mechanical Properties

Material: Class 8.8 High Tensile

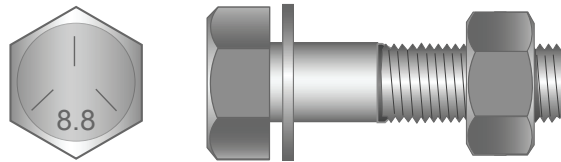

BOLT & NUT AF (MM)		HARDNESS		
M16	27MM	BOLT & NUT	23 - 36	HRC
M20	32MM	WASHER	26 - 45	HRC
M24	41MM			
M30	50MM	BOLT TENSILE	830 MPA	
M36	60MM			

Batch Sample Test Certification Reports available on request

Detailed Specifications for AS 1252 available on request

Durability

Hot Dipped Galvanised - 98% Zinc - 45 Microns

Bolt/Nut to AS 1214

Washer to AS 1650

SPECIFICATION SHEET

Steel Coach Screws

Manufactured to AS 1393

Material: Class 4.6 Mild Steel

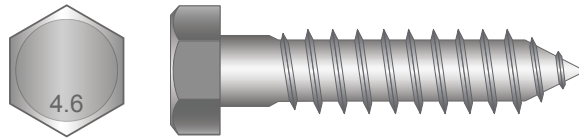

HEAD DIAMETER AF (MM)		PILOT HOLE DIAMETER	
SCREW SIZE	HEAD AF	SCREW SIZE	DRILL DIA
M6	10MM	M6	4.0 - 4.5MM
M8	13MM	M8	5.0 - 6.0MM
M10	16MM	M10	6.5 - 7.5MM
M12	18MM	M12	8.0 - 9.0MM
M16	24MM	M16	12.0 - 13.0MM
M20	30MM	M20	15.0 - 16.0MM
TENSILE STRENGTH - 400 MPa			

Durability

Hot Dipped Galvanised - 98% Zinc - 45 Microns

Typical Life - 25-50 Years

SPECIFICATION SHEET

Stainless Steel Coach Screws

Manufactured to Din 571

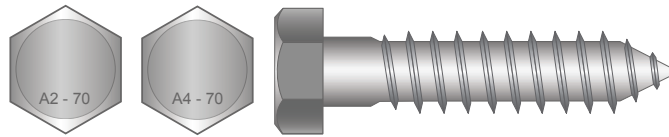

HEAD DIAMETER AF (MM)		PILOT HOLE DIAMETER	
SCREW SIZE	HEAD AF	SCREW SIZE	DRILL DIA
M6	10MM	M6	4.0 - 4.5MM
M8	13MM	M8	5.0 - 6.0MM
M10	16MM	M10	6.5 - 7.5MM
M12	18MM	M12	8.0 - 9.0MM
M16	24MM	M16	12.0 - 13.0MM
M20	30MM	M20	15.0 - 16.0MM
TENSILE STRENGTH - 700 MPa			
TYPICAL CHEMICAL COMPOSITION			
T304 (A2)		T316 (A4)	
CHROMIUM 18%		CHROMIUM 18%	
NICKEL 8%		NICKEL 8%	
		MOLYBDENUM 2.2%	

SPECIFICATION SHEET

Steel Coach Bolt & Nut METRIC COURSE

MANUFACTURED TO: AS 1390 METRIC SERIES 4.6

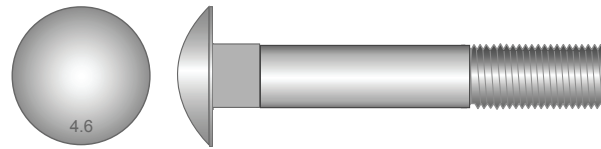

SIZE	PITCH Distance between threads(mm)	AF Of Square Neck (mm)	THREAD LENGTH (NOMINAL)		
			Up to 125mm	Over 125 to 20mm	Over 200mm
M6	1.00mm	10mm	18mm	24mm	
M8	1.25mm	13mm	22mm	28mm	
M10	1.50mm	16mm	26mm	32mm	45mm
M12	1.75mm	18mm	30mm	36mm	49mm
M16	2.00mm	24mm	38mm	44mm	57mm
M20	2.50mm	30mm	46mm	52mm	65mm

BREAKING LOAD OF BOLT	
SIZE	CLASS 4.6
M6	8.0 kN
M8	14.6 kN
M10	23.2 kN
M12	33.7 kN
M16	62.8 kN
M20	98.0 kN
M24	141.0 kN

TENSILE STRENGTH (MINIMUM)
400 MPa

Durability

Bright Zinc:
 3-5 Microns

Recommended for indoor use only

Hot Dipped Galvanised - 98% Zinc - 45 Microns

PRODUCT DIMENSIONS
METRIC HEXAGON BOLTS TO AS1110

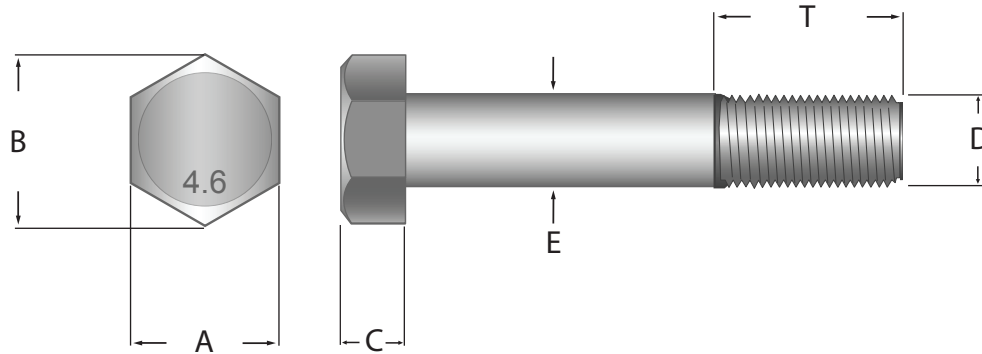

D DIA	PITCH MM	A ACROSS FLATS		B	C	E	
		MAX	MIN	ACROSS CORNERS MIN	HEAD HEIGHT MAX	SHANK DIAMETER	
						MAX	MIN
M5	0.8	8	7.78	9.2	3.5	5	4.82
M6	1	10	9.78	11.5	4	6	5.82
M8	1.25	13	12.73	15	5.3	8	7.78
M10	1.5	16	15.73	18.4	6.4	10	9.78
M12	1.75	18	17.73	20.7	7.5	12	11.73
M14	2	21	20.67	24.2	8.8	14	13.73
M16	2	24	23.67	27.7	10	16	15.73
M18	2.5	27	26.67	31.2	11.5	18	17.73
M20	2.5	30	29.67	34.6	12.5	20	19.67
M22	2.5	34	33.38	39.3	14	22	21.67
M24	3	36	35.38	41.6	15	24	23.67
M27	3	41	40.38	47.3	16.7	27	26.67
M30	3.5	46	45	53.1	18.7	30	29.67
M33	3.5	50	49	57.7	20.5	33	32.61
M36	4	55	53.8	63.5	22.5	36	35.61

NOMINAL THREAD LENGTHS FOR HEXAGON BOLTS	
NOMINAL LENGTH OF BOLT	THREAD LENGTH (T)
UP TO 25mm	Thread = 2D + 6mm
OVER 125MM, UP TO 200mm	Thread = 2D + 12mm
OVER 200mm	Thread = 2D + 25mm
**WHERE D IS THE DIAMETER	

PRODUCT DIMENSIONS
IMPERIAL HEXAGON BOLTS TO AS2465

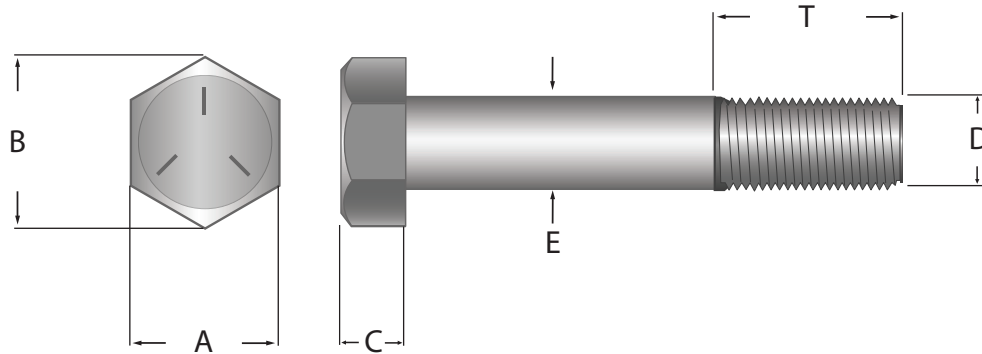

DIA	PITCH TPI		A ACROSS FLATS		B ACROSS CORNERS		C HEAD HEIGHT		E SHANK DIAMETER	
	UNC	UNF	MAX	MIN	MAX	MIN	MAX	MIN	MAX	MIN
1/4"	20	28	0.438	0.428	0.505	0.488	0.163	0.15	0.25	0.245
5/16"	18	24	0.5	0.489	0.577	0.557	0.211	0.195	0.313	0.306
3/8"	16	24	0.562	0.551	0.65	0.628	0.234	0.226	0.375	0.369
7/16"	14	20	0.625	0.612	0.722	0.698	0.291	0.272	0.438	0.43
1/2"	13	20	0.75	0.736	0.866	0.84	0.323	0.302	0.5	0.493
9/16"	12	18	0.812	0.798	0.938	0.91	0.371	0.348	0.563	0.554
5/8"	11	18	0.938	0.922	1.083	1.051	0.403	0.378	0.625	0.617
3/4"	10	16	1.125	1.100	1.299	1.254	0.483	0.455	0.75	0.741
7/8"	9	14	1.312	1.285	1.516	1.465	0.563	0.531	0.875	0.866
1"	8	12	1.5	1.469	1.732	1.675	0.627	0.591	1	0.99
1.1/8"	7	12	1.688	1.631	1.949	1.859	0.718	0.658	1.125	1.114
1.1/4"	7	12	1.875	1.812	2.165	2.066	0.813	0.749	1.25	1.239
1.3/8"	6	12	2.062	1.994	2.382	2.273	0.878	0.81	1.375	1.363
1.1/2"	6	12	2.25	2.175	2.598	2.48	0.974	0.902	1.5	1.488
1.3/4"	5		2.625	2.538	3.031	2.893	1.134	1.054	1.75	1.738
2"	4.5		3	2.9	3.464	3.306	1.263	1.175	2	1.988

NOMINAL THREAD LENGTHS FOR HEXAGON BOLTS

NOMINAL LENGTH OF BOLT	THREAD LENGTH (T)
UP TO 6"	Thread = 2D + 1/4"
OVER 6"	Thread = 2D + 1/2"
	**WHERE D IS THE DIAMETER

**PROOF LOADS AND TENSILE STRESS
FOR METRIC HEXAGON BOLTS TO AS 1110 CLASS 4.6 & CLASS 8.8**

DIA	TENSILE STRESS AREA mm ²	CLASS 4.6 TO AS 111		CLASS 8.8 TO AS 1110	
		PROOF LOAD kN	TENSILE LOAD kN min	PROOF LOAD kN	TENSILE LOAD kN min
M5	14.2	3.20	5.68	8.23	11.35
M6	20.1	4.52	8.04	11.6	16.1
M8	36.6	8.24	14.6	21.2	29.2
M10	58.0	13.0	23.2	33.7	46.4
M12	84.3	19.0	33.7	48.9	67.4
M14	115	25.9	46.0	66.7	92.0
M16	157	35.3	62.8	91	125
M18	192	43.2	76.8	115	159
M20	245	55.1	98.0	147	203
M22	303	68.2	121	182	252
M24	353	79.4	141	212	293
M27	459	103	184	275	381
M30	561	126	224	337	466
M33	694	156	278	416	576

**PROOF LOADS AND TENSILE STRESS
FOR IMPERIAL HEXAGON BOLTS TO AS 2465 GRADE 5 & GRADE 8**

DIA	UNC THREADS			UNF THREADS		
	TENSILE STRESS AREA in ²	PROOF LOAD lbf	TENSILE LOAD lbf min	TENSILE STRESS AREA in ²	PROOF LOAD lbf	TENSILE LOAD lbf min
GRADE 5						
1/4"	0.0318	2,700	3,800	0.0364	3,100	4,350
5/16"	0.0524	4,450	6,300	0.058	4,900	6,950
3/8"	0.0775	6,600	9,300	0.0878	7,450	10,500
7/16	0.1063	9,050	12,800	0.1187	10,100	14,200
GRADE 8						
1/2"	0.1419	17,000	21,300	0.1599	19,200	24,000
5/8"	0.2260	27,100	33,900	0.256	30,700	38,400
3/4"	0.3340	40,100	50,100	0.373	44,800	56,000
7/8"	0.4620	55,400	69,300	0.509	61,100	76,400
1"	0.6060	72,700	90,900	0.663	79,600	99,400
1.1/8"	0.7630	91,600	114,400	0.856	102,700	128,400
1.1/4"	0.9690	116,300	145,400	1.073	128,800	161,000
1.1/2"	1.4050	168,600	210,800	1.581	189,700	237,000



100% NZ Owned & Operated